

WWW.SURVIVALEBOOKS.COM

YOUR LAST LINE IN DEFENSE AND SURVIVAL

CHECK OUT OUR WEBSITE SOME TIME FOR PLENTY OF ARTICES ABOUT SELF DEFENSE,
SURVIVAL, FIREARMS AND MILITARY MANUALS.

<http://www.survivalebooks.com/>

Thank you for purchasing our ebook package.

OBSTACLES, MINES, AND DEMOLITIONS

Obstacles and mines are used extensively in combat in built-up areas to allow the defender to canalize the enemy, impede his movement, and disrupt his attack.

Section I. OBSTACLES

Obstacles are designed to prevent movement by personnel, to separate infantry from tanks, and to slow or stop vehicles.

C-1. TYPES

Antipersonnel mines, barbed wire, booby traps, and exploding flame devices are used to construct antipersonnel obstacles (Figure C-1, page C-2). (See FM 5-25 for more detailed information.) These obstacles are used to block the following infantry approaches:

- Streets.
- Buildings.
- Roofs.
- Open spaces.
- Dead space.
- Underground systems.

a. The approval authority to booby trap buildings is the Corps commander; however, this authority may be delegated to brigade level. (See FM 20-32 for more information.)

b. The three types of obstacles used in defensive operations are protective, tactical, and supplementary.

(1) Protective obstacles are usually located beyond hand-grenade range (40 to 100 meters) from the defensive position.

(2) Tactical obstacles are positioned to increase the effectiveness of the friendly weapons fire. The tactical wire is usually positioned on the friendly side of the machine gun FPLs.

(3) Supporting obstacles are used to breakup the pattern of tactical wire to prevent the enemy from locating friendly weapons.

c. Dead space obstacles are designed and built to restrict infantry movement in areas that cannot be observed and are protected from direct fires.

d. Antiarmor obstacles are restricted to streets (Figure C-2, page C-4).

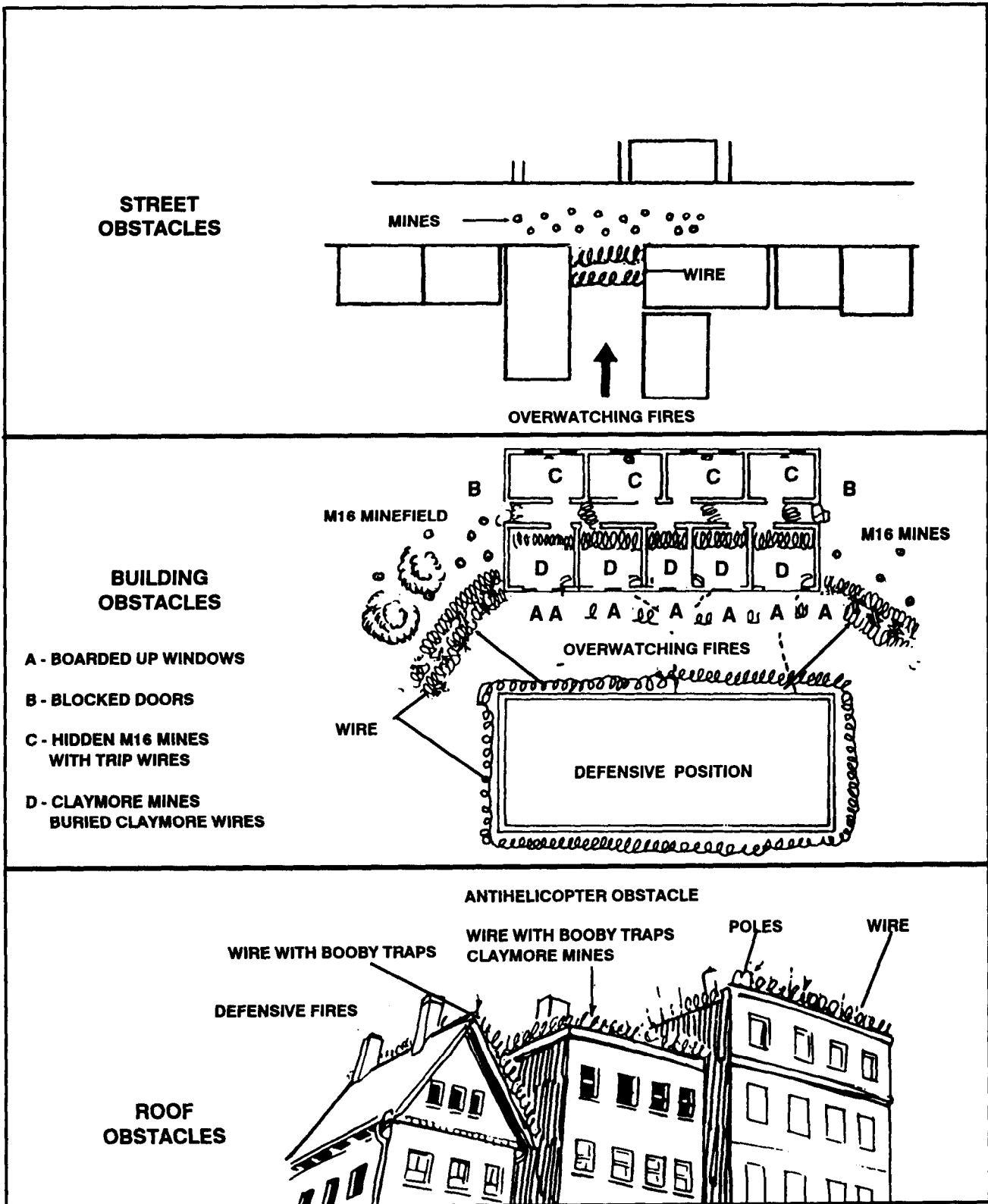

Figure C-1. Antipersonnel obstacles.

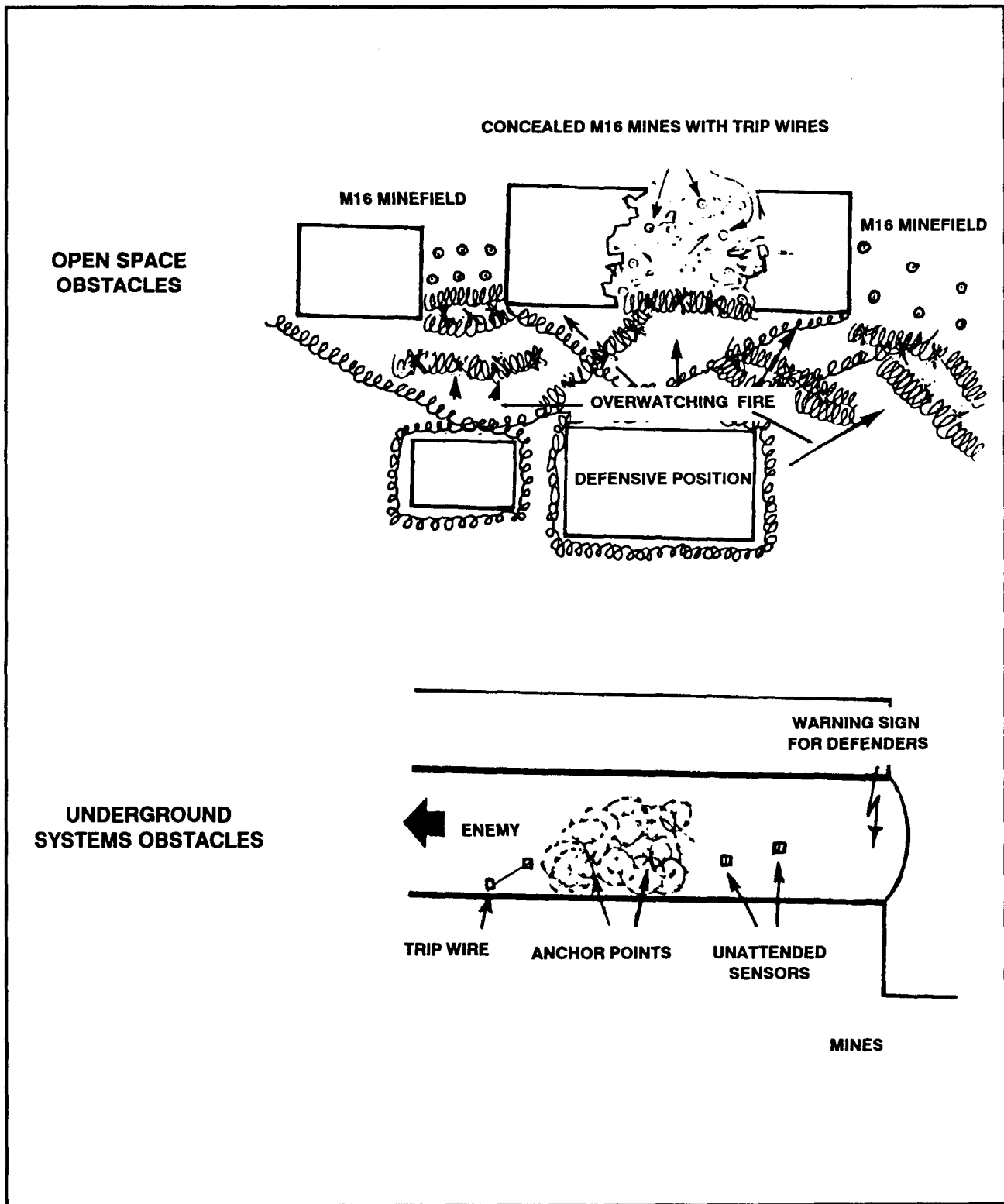

Figure C-1. Antipersonnel obstacles (continued).

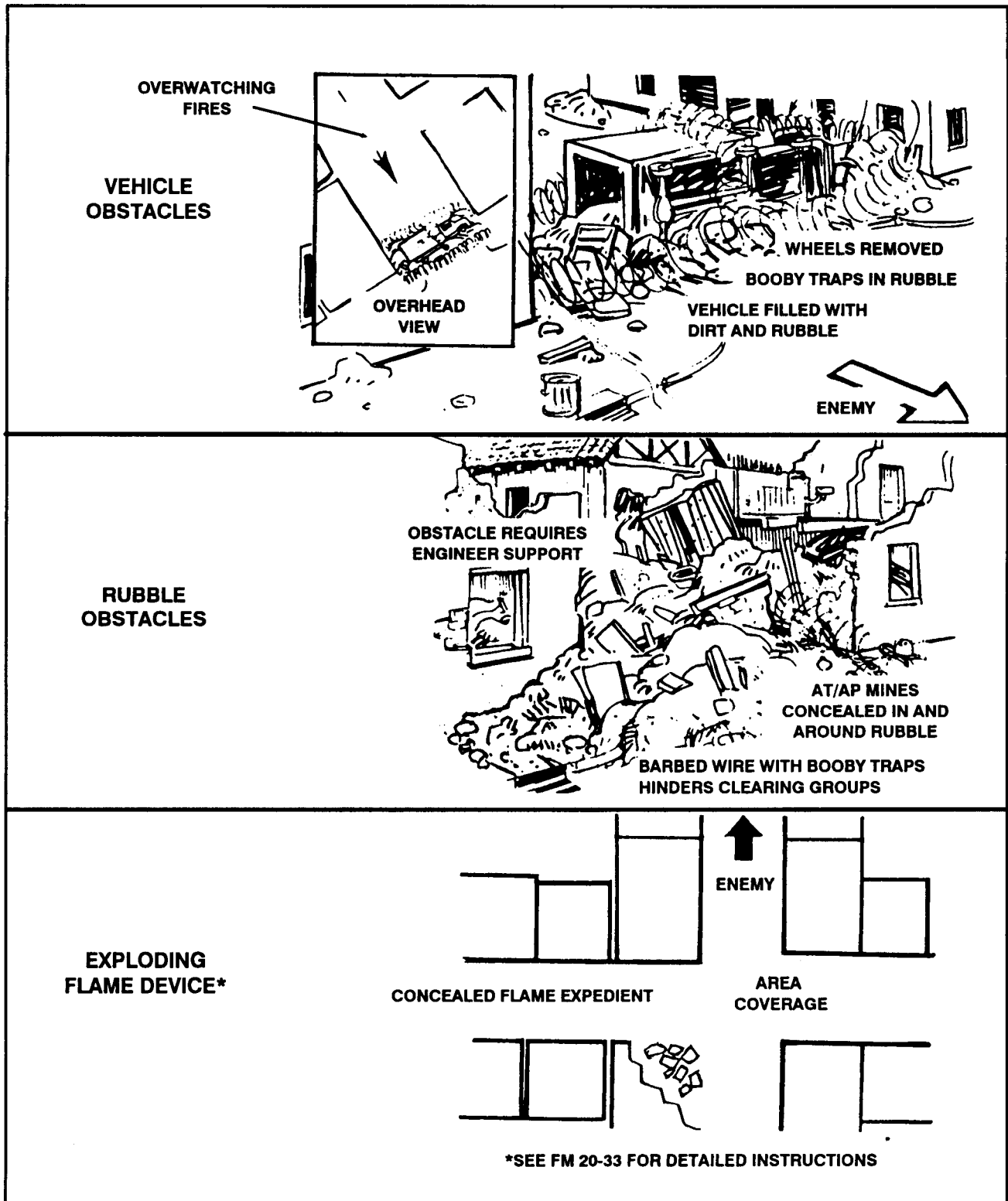

Figure C-2. Antiarmor obstacles.

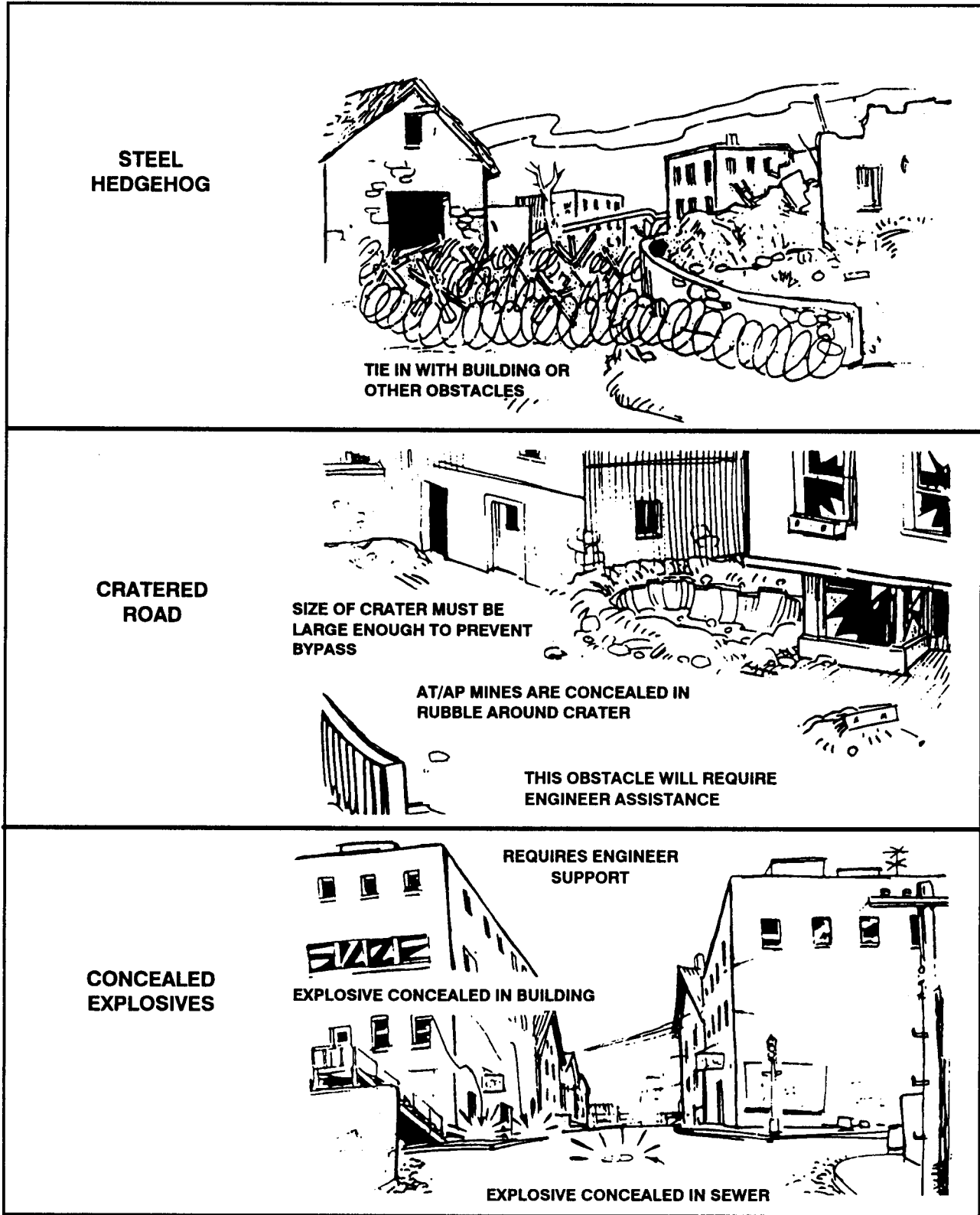

Figure C-2. Antiarmor obstacles (continued).

C-2. CONSTRUCTION OF OBSTACLES

Obstacles are constructed in buildings to deny enemy infantry covered routes and weapons positions close to friendly defensive positions. They can be constructed by rubble with explosives or flame, by using wire, or by using booby traps within buildings. The building can be prepared as an explosive or flame trap for execution after enemy occupation.

Section II. MINES

Mines in built-up areas should be recorded on a building sketch (Figure C-3) and on a DA Form 1355 or DA Form 1355-1-R. (See M 20-32 for instructions on how to complete these forms.) The sketch should include the number of the building (taken from a city map) and all floor plans. It should also include the type of mine and firing device. When possible, mined buildings should be marked on the friendly side (Figure C-4). Clearing areas or buildings that have been mined is extremely difficult. Therefore, they should be considered "NO GO" areas. This factor must be carefully considered when planning and authorizing the placement of mines. (See Table C-1 for the approving authority for minefield.)

TYPE MINEFIELD	APPROVING AUTHORITY
Protective hasty	Brigade commander (may be delegated down to battalion or company level on a mission basis).
Deliberate	Division or Installation commander.
Tactical	Division commander (may be delegated to brigade level).
Point	Brigade commander (may be delegated to battalion level).
Interdiction	Corps commander (may be delegated to division level).
Phony	Corps commander (may be delegated to division level).
Scatterable long duration (24 hours or more)	Corps commander (may be delegated to division or brigade level).
Short duration (less than 24 hours)	Corps commander (may be delegated to division , brigade, or battalion level).

Table C-1. Minefield employment authority.

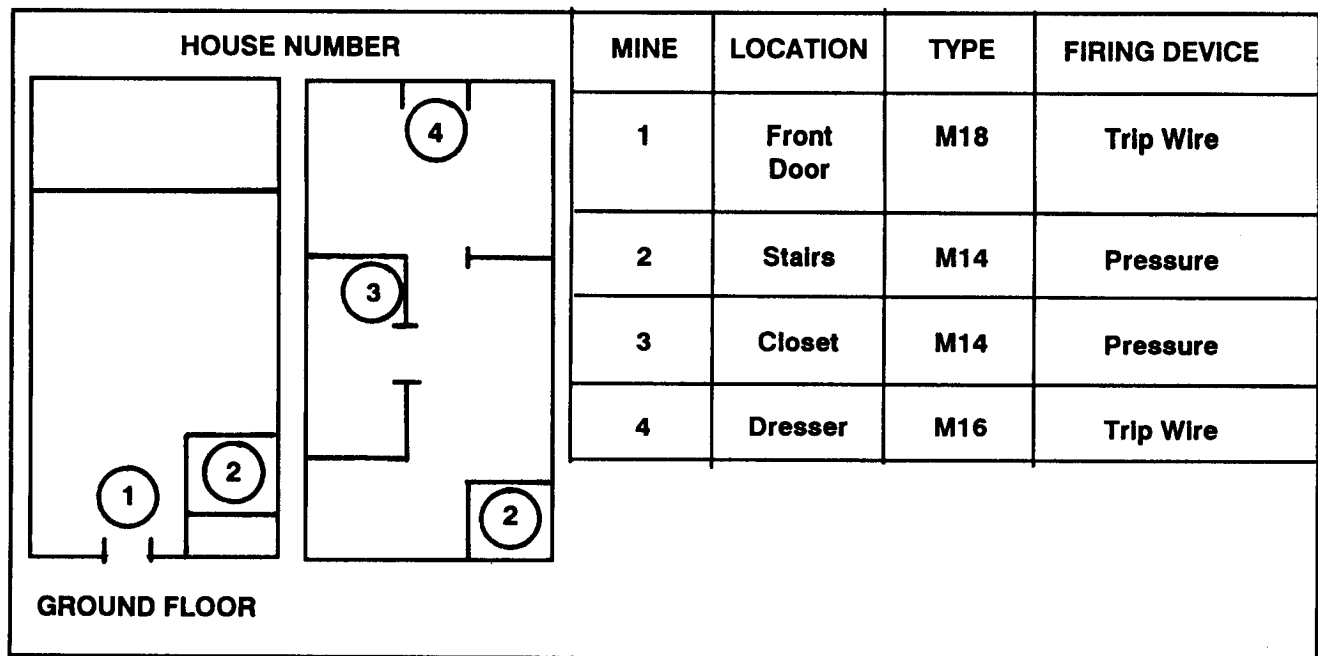

Figure C-3. Building sketch showing mines.

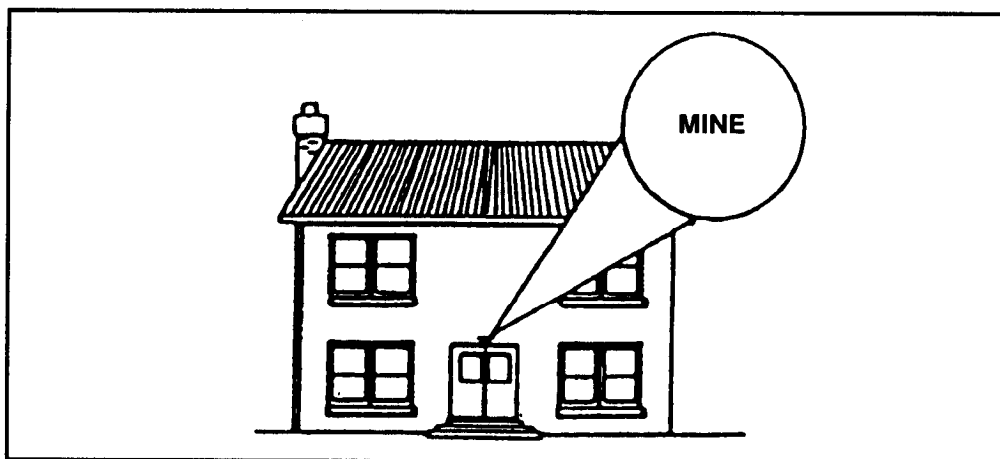

Figure C-4. Marking of mined buildings.

C-3. TYPES

Several types of mines can be employed in built-up areas.

a. The M14 mine should be used with metallic antipersonnel, antitank, or chemical mines to confuse and hinder enemy breaching attempts. It must be carefully employed because its light weight makes it easy to displace (Figure C-5, page C-8). However, its size makes it ideal for obscure places such as stairs and cellars.

b. The M16 mine is ideal for covering large areas such as rooftops, backyards, parks, and cellars. It should be expediently rigged for command detonation by attaching a rope or piece of communications wire to the release pin ring (Figure C-6, page C-8).

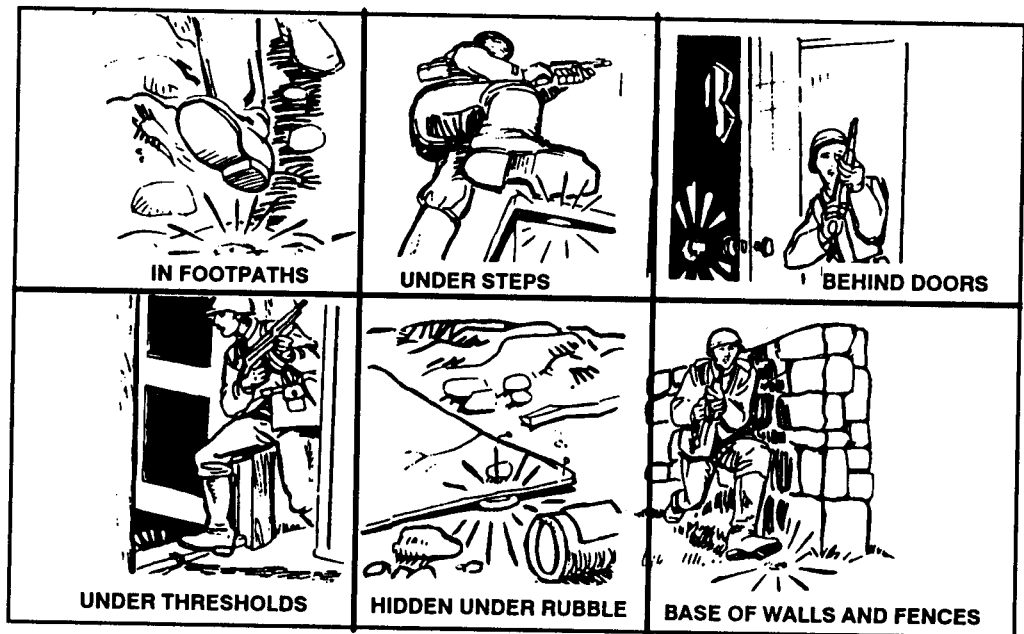

Figure C-5. Emplacing the M14 antipersonnel mine.

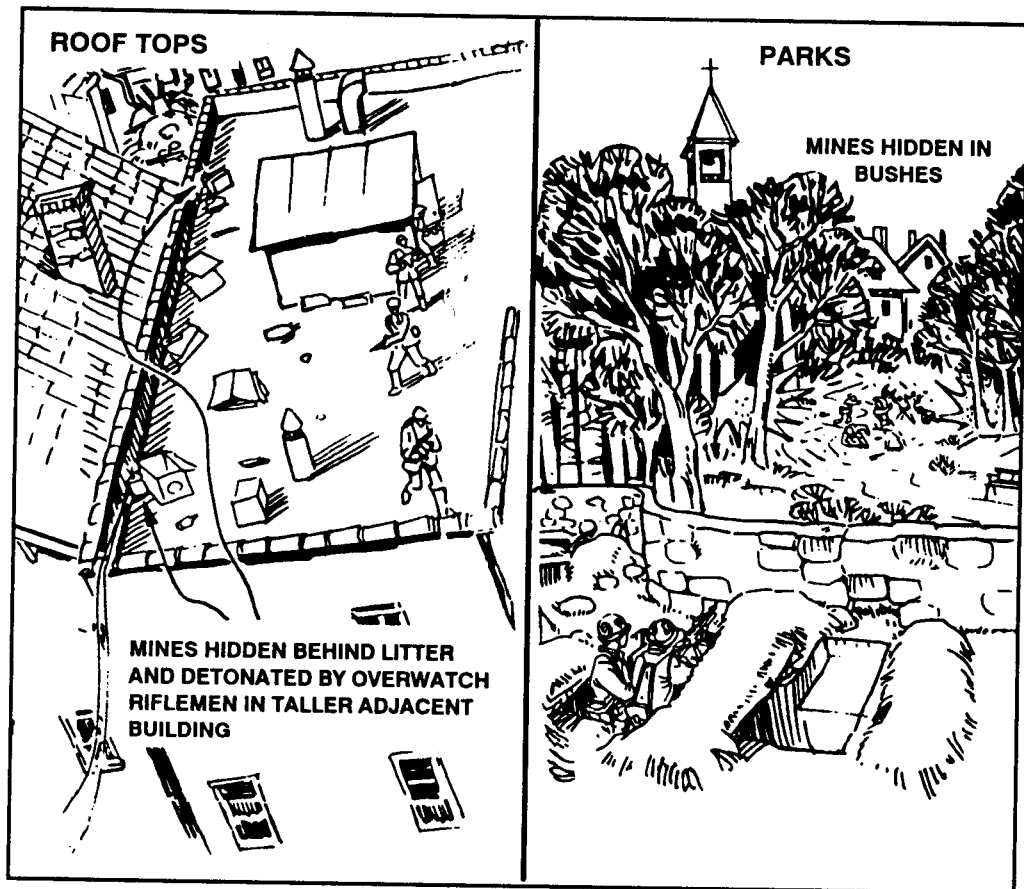

Figure C-6. Emplacements of M16 antipersonnel mines.

c. The M18A1 Claymore mine can be employed during the reorganization and consolidation phase on likely enemy avenues of approach. It does not have to be installed in the street but can be employed on the sides of buildings or any other sturdy structure.

(1) Claymore mines can be used for demolition against thin-skinned buildings and walls, or the 1 1/2 pounds of composition 4 can be removed from the mine and used as an explosive, if authorized.

(2) Claymore mines arranged for detonation by trip wire can be mixed with antipersonnel and antitank mines in nuisance minefield. They can fill the dead space in the final protective fires of automatic weapons (Figure C-7).

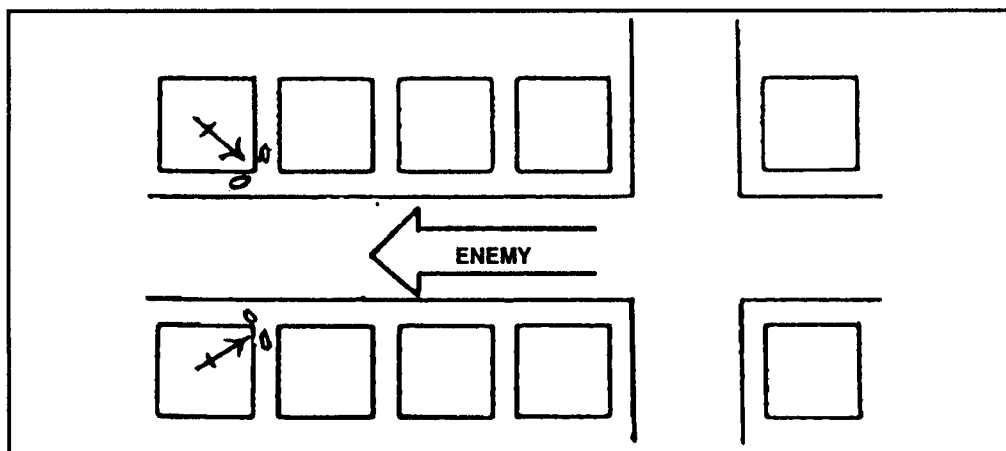

Figure C-7. Claymore mine used to cover dead space of automatic weapons.

(3) Claymore mines can be used several ways in the offense. For example, if friendly troops are advancing on a city, Claymore mines can be used in conjunction with blocking positions to cut off enemy avenues of escape (Figure C-8).

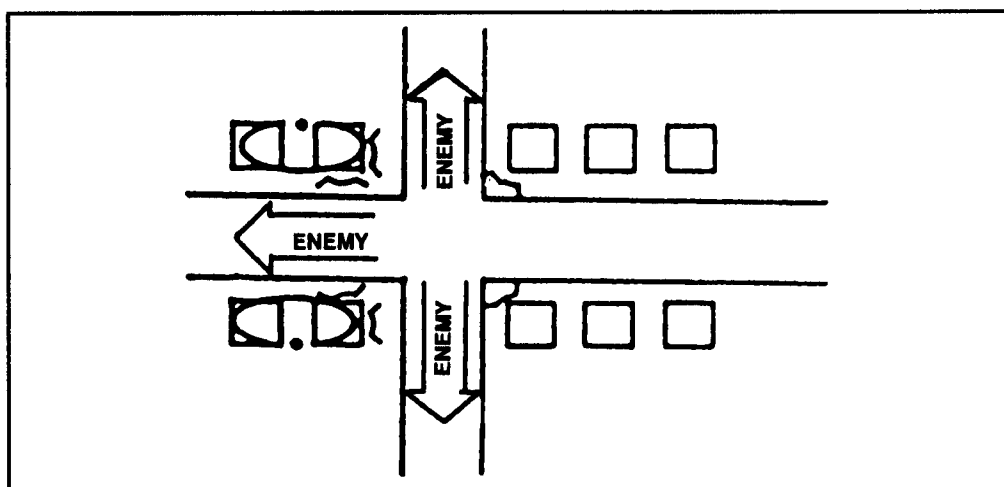

Figure C-8. Claymore mines used to block enemy avenues of escape.

- d. The M15, M19, and M21 antitank mines are employed (Figure C-9)—
- In conjunction with other man-made obstacles and covered with fire.
 - As standard minefield in large open areas with the aid of the M57 dispenser.
 - In streets or alleys to block routes of advance in narrow defiles.
 - As command detonated mines with other demolitions.

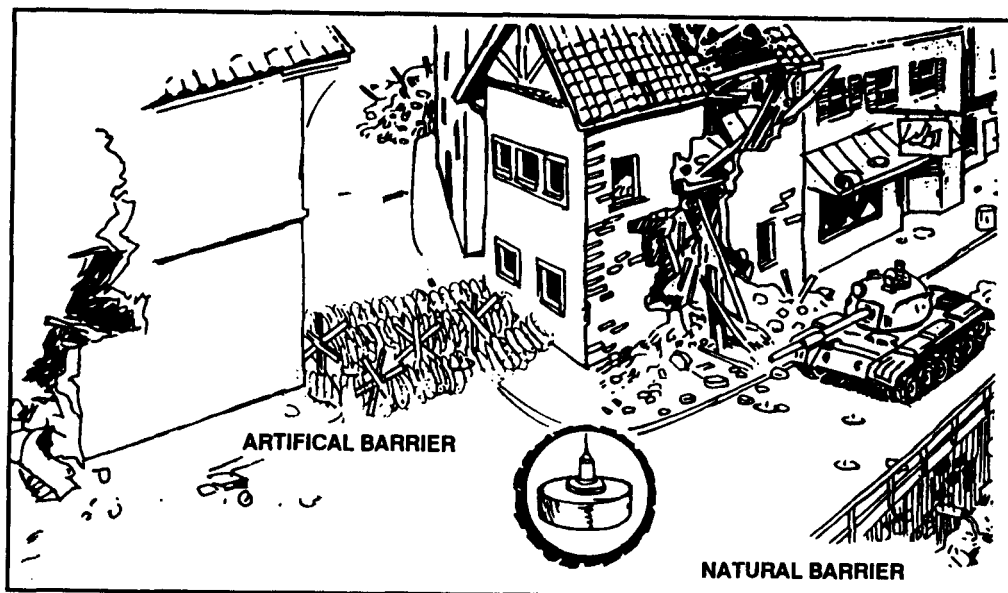

Figure C-9. Emplacement of antitank mines.

C-4. ENEMY MINES AND BOOBY TRAPS

Buildings contain many areas and items that are potential hiding places for booby traps—for example, doors, windows, telephones, stairs, books, canteens, and so on.

When moving through a building, soldiers must not pick up anything—food, valuables, enemy weapons, and so on. Such items could be rigged with pressure devices that explode when they are moved. Soldiers must be well dispersed so that if a booby trap explodes, the number of casualties will be few. Many different types of mines and booby traps could be encountered during combat in built-up areas (Figure C-10).

- a. The equipment used in clearing operations is—
- Mine detectors.
 - Probes.
 - Grappling hooks.
 - Ropes.
 - C4 explosives.
 - Flak vests.
 - Eye protection.
 - Engineer tape.

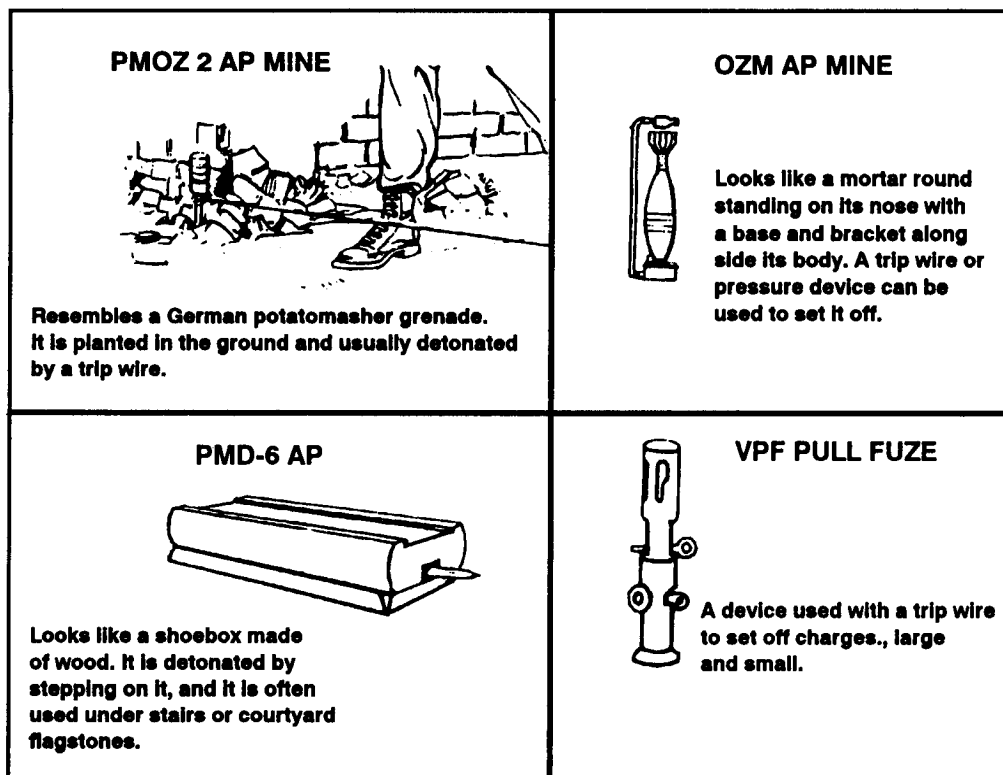

Figure C-10. Threat mines and booby traps.

b. If available, scout dogs should be used to "alert" soldiers to trip wires or mines.

c. To detect trip wires, soldiers can use a 10-foot pole with 5 feet of string tied on one end. He attaches a weight to the loose end of the string, which snaps on the trip wire. This allows the lead man to easily detect a trip wire (Figure C-11).

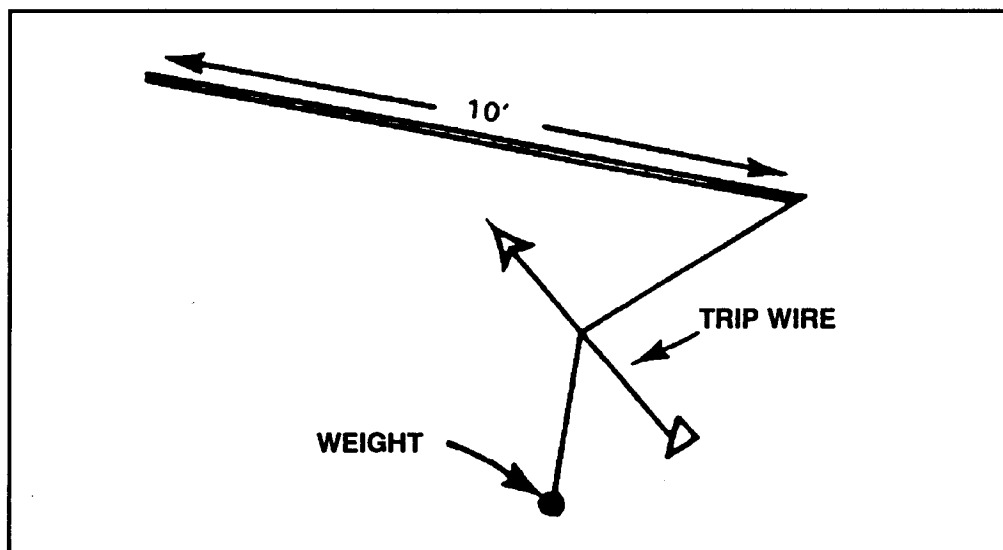

Figure C-11. Trip wire detection.

d. Many standard antipersonnel mines are packed in boxes and crates. If a soldier discovers explosive storage boxes, he should sketch them and turn the sketchover to the platoon leader or S2.

e. Most booby traps should be neutralized by explosive ordnance disposal (EOD) personnel. If EOD teams are not available, booby traps can be blown in place. Personnel should be protected by adequate cover. If the booby trap is in a building, all personnel should go outside before the booby trap is destroyed. Engineer tape placed around the danger area is one method of marking booby traps. If tape is not available, strips ripped from bedsheets can be used. If possible, a guide should lead personnel through booby-trapped areas. Prisoners and civilians can be a good source of information on where and how booby traps are employed. Figure C-10 shows some of the types of Threat mines and booby traps that could be encountered.

Section III. DEMOLITIONS

Demolitions are used more often during combat in built-up areas than during operations in open natural terrain. Demolition operations should be enforced by the engineers that support the brigade, battalion task force, and company team. However, if engineers are involved in the preparation and execution of the barrier plan, infantrymen can prepare mouseholes, breach walls, and rubble buildings themselves, assisted and advised by the brigade, task force, or team engineer.

C-5. OFFENSIVE USE

When assaulting or clearing a built-up area, demolitions enable the maneuver commander to create an avenue of approach through buildings. As discussed earlier in the text, the infantry commander forms his personnel into assault teams and overwatch teams for seizing and clearing buildings.

a. Every other man in an assault team should carry demolitions, and other selected personnel should carry blasting caps. In a fire team, one man should carry the demolitions. The same man should not carry both the explosives and the blasting caps. As the demolitions are expended by the assault teams, they should be replaced by explosives carried by the overwatch force.

b. One of the most difficult breaching operations faced by the assault team is the breaching of masonry and reinforced concrete walls. When demolitions must be used, composition C4 is the ideal charge to use. Normally, building walls are 15 inches thick or less. Assuming that all outer walls are constructed of reinforced concrete, a rule of thumb for breaching is to place 10 pounds of C4 against the target between waist and chest height. When detonated, this normally blows a hole large enough for a man to go through. The amounts of TNT required to breach concrete are shown in Figure C-12.

c. However, metal reinforcing rods cannot be cut by this charge. Once exposed, they can be removed by using saddle or diamond charges on the rods. Hand grenades should be thrown into the opening to clear the area of enemy (see FM 5-25, Chapter 3).

REINFORCED CONCRETE		
THICKNESS OF MATERIAL	TNT	SIZE OF OPENING
Up to 10 CM (4 inches)	5 KG (11 lbs)	10 to 15 CM (4 to 6 inches)
10 to 15 CM (4 to 6 inches)	10 KG (22 lbs)	15 to 25 CM (6 to 10 inches)
15 to 20 CM (6 to 8 inches)	20 KG (44 lbs)	20 to 30 CM (8 to 12 inches)
NONREINFORCED CONCRETE MASONRY		
THICKNESS OF MATERIAL	TNT	SIZE OF OPENING
Up to 35 CM (14 inches)	1 KG (2.2 lbs)	35 CM (14 inches)
35 to 45 CM (14 to 18 inches)	2 KG (4.4 lbs)	45 CM (18 inches)
45 to 50 CM (18 to 20 inches)	3 KG (6.6 lbs)	50 CM (20 inches)

Figure C-12. TNT required to breach concrete.

d. Mouseholes provide the safest method of moving between rooms and floors. They can be created with C4. Since C4 comes packaged with an adhesive backing or can be emplaced using pressure-sensitive tape, it is ideal for this purpose. When using C4 to blow a mousehole in a lath and plaster wall, one block or a strip of blocks should be placed on the wall from neck-to-knee height. Charges should be primed with detonating cord or electrical blasting caps to obtain simultaneous detonation, which will blow a hole large enough for a man to fit through.

C-6. DEFENSIVE USE

The use of demolitions in defensive operations is the same as in offensive operations. When defending a built-up area, demolitions are used to create covered and concealed routes through walls and buildings that can be used for withdrawals, reinforcements, or counterattacks. Demolitions are also used to create obstacles and clear fields of fire.

a. Infantrymen use demolitions for creating mouseholes and constructing command-detonated mines. Expedient C4 satchel charges can be concealed in likely enemy weapons, in firing positions, or on movement routes. Expedient-shaped charges (effective against lightly armored vehicles) can also be emplaced on routes of mounted movement when integrated into antiarmor ambushes.

b. The engineers must furnish technical assistance for selective rubbling. Normally, buildings can be rubbed by using shaped charges or C4 on the supports and major beams of buildings.

c. Charges should be placed directly against the surface that is to be breached (Figure C-12), unless a shaped charge is used. Whenever possible, demolitions should be tamped to increase their effectiveness. Tamping materials could be sandbags, rubble, or desks and chairs (Figure C-13).

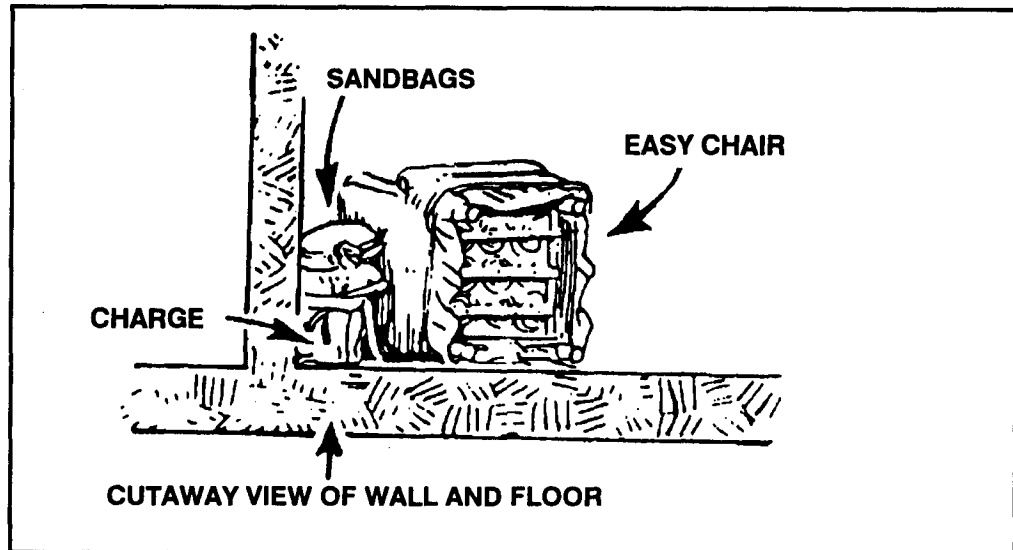

Figure C-13. Chair used to tamp breaching charge.

d. For most exterior walls, tamping of breaching charges could be impossible due to enemy fire. Thus, the untamped charge requires twice the explosive charge to produce the same effect as an elevated charge (Figure C-14).

METHODS OF PLACEMENT				
THICKNESS OF CONCRETE				
	FEET	POUNDS OF TNT	POUNDS OF C4	POUNDS OF TNT
2	14	11	28	21
2 1/2	27	21	54	41
3	39	30	78	59
3 1/2	62	47	124	93
4	93	70	185	138
4 1/2	132	99	263	196
5	147	106	284	211
5 1/2	189	141	376	282
6	245	186	490	366

Figure C-14. Breaching reinforced concrete.

e. When enemy fire prevents an approach to the wall, the breaching charge must be attached to a pole and slid into position for detonation at the base of the wall untamped (Figure C-15). Small-arms fire will not detonate C4 or TNT; the charge must be primed with detonating cord. Soldiers must take cover before detonating the charge.

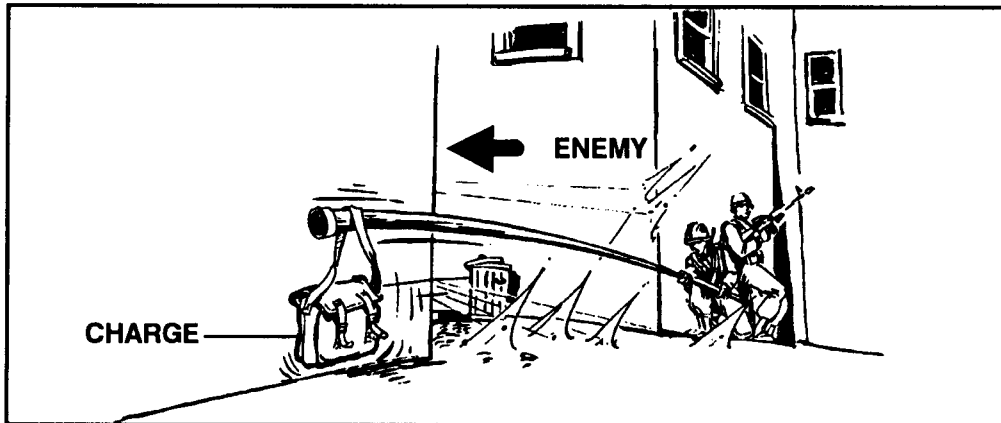

Figure C-15. Charge placement when small-arms fire cannot be suppressed.

f. The internal walls of most buildings function as partitions rather than load-bearing members. Therefore, smaller explosive charges can be used to breach them. In the absence of C4 or other military explosives, internal walls can be breached by using one or more hand grenades or a Claymore mine (Figure C-16). These devices should be tamped to increase their effectiveness and to reduce the amount of explosive force directed to the rear.

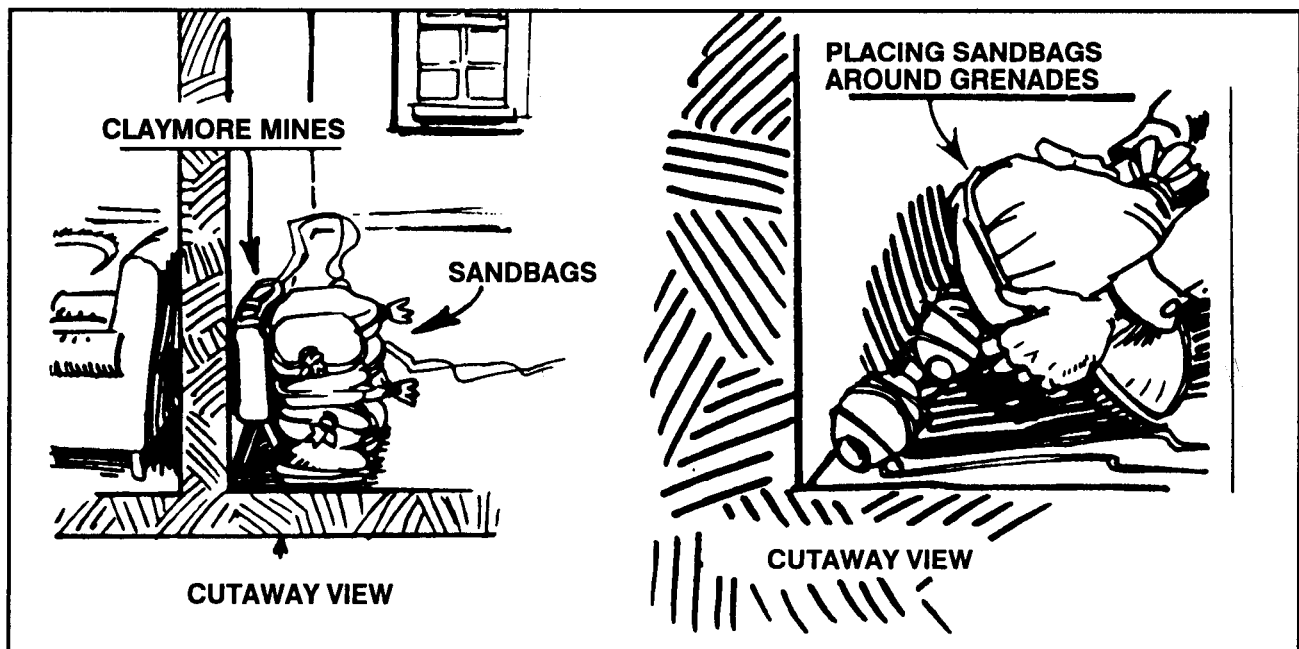

Figure C-16. Tamping of a Claymore mine and hand grenades to breach internal walls.

g. The Molotov cocktail (Figure C-17) is an expedient device for disabling both wheeled and tracked vehicles. It is easy to make since the materials are readily available. The results are most effective because of the close engagement in built-up areas. The objective is to ignite a flammable portion of the vehicle such as the fuel or ammunition that it is transporting. The following materials are needed to make a Molotov cocktail:

- Container-bottle or glass container.
- Gas (60 percent).
- Oil (40 percent).
- Rag for use as a wick.

The gas and oil are mixed thoroughly (60 percent gas to 40 percent oil). The rag is soaked with the mixture, and then the mixture is placed into the bottle. The rag is then inserted in the opening of the bottle as a wick. When a target is sighted, the wick is lit and the bottle is thrown hard enough to break.

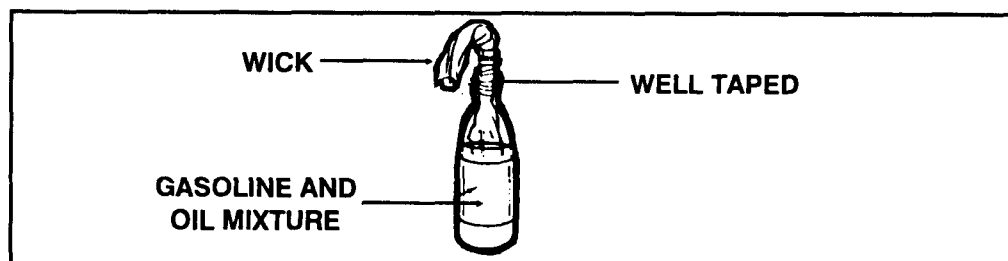

Figure C-17. Molotov cocktail.

WARNING

Ensure that a safe distance is maintained when throwing the Molotov cocktail. Caution troops against dropping the device. Throw it in the opposite direction of personnel and flammable materials. Do not smoke while making this device.

h. The bunker bomb (Figure C-18) is an expedient explosive flame weapon best used against fortified positions or rooms. This expedient munition should be used with a mechanical rather than an electrical firing system. The following materials are required to make a bunker bomb:

- 1 small-arms ammunition container.
- 1 gallon of gasoline.
- 50 feet of detonating cord.
- 1 nonelectric blasting cap.
- 1 M60 fuse igniter.
- 7 1/2 feet of M700 time fuse.
- 3 ounces of M4 thickening compound.
- 1 M49 trip flare or M34 WP grenade.

(1) **Step 1.** Fill the ammunition can 3/4 full with thickened flame fuel and secure the lid.

(2) **Step 2.** "Hasty whip" the device with 15 turns around the center of the container using 44 feet of detonating cord. Leave 2-foot "pigtails" for attaching the igniter and fuse igniter.

(3) **Step 3.** Tape the igniter (M49 trip flare or M34 WP grenade) to the container handle.

(4) **Step 4.** Place one detonating cord pigtail end under the igniter spoon handle. Tape it in place.

(5) **Step 5.** Attach the M60 fuse igniter and the nonelectrical blasting cap to the M700 time fuse.

(6) **Step 6.** Attach the nonelectrical firing system to the other pigtail by making a loop in the detonating cord and attaching the blasting cap to it.

(7) **Step 7.** Remove the safety pin from the igniter (M49 trip flare or M34WP grenade). The device is ready to be fired.

WARNING

Never carry the device by the handle or igniter. Remove the igniter safety pin only when it is time to use the device. Use extreme care when handling or carrying nonelectrical firing systems. Protect blasting caps from shock and extreme heat. Do not allow the time fuse to kink or become knotted. Doing so may disrupt the powder train and may cause a misfire. Prime detonating cord and remove the time fuse igniter safety pin only when it is time to use the device.

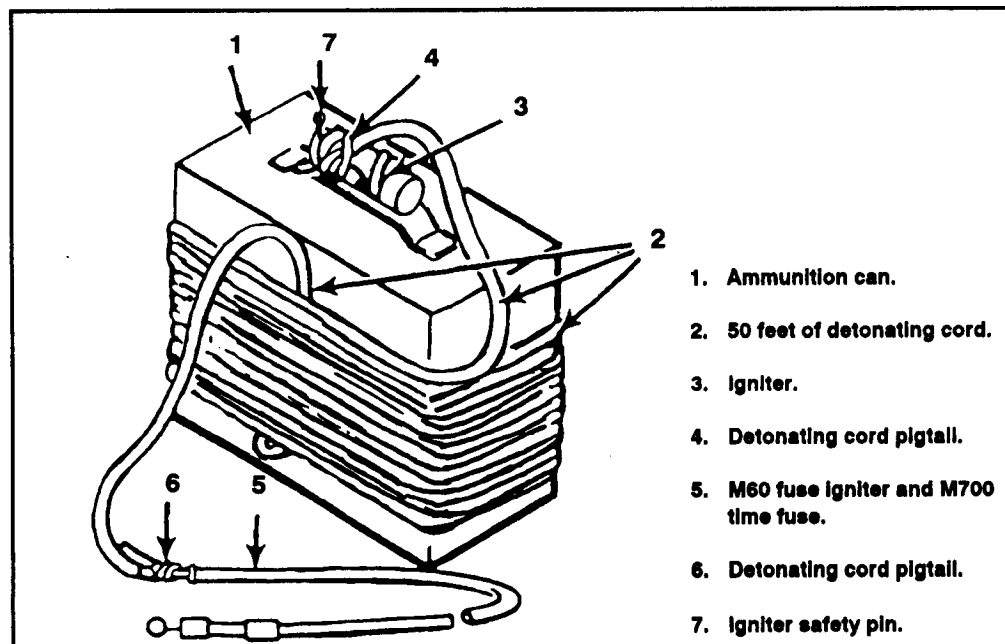

Figure C-18. Bunker bomb made from an ammunition can.

C-7. SAFETY

The greatest danger to friendly personnel from demolitions is the debris thrown by the explosion. Leaders must ensure that protective measures are enforced. The safe distance listed in Table C-2 indicates the danger of demolition effects.

- a. The following are the rules for using demolitions:
 - Keep the blasting machine under the control of an NCO.
 - Wear helmets at all times while firing explosives.
 - Handle misfires with extreme care.
 - Clear the room and protect personnel when blowing interior walls.
- b. Some charges should be prepared, minus detonators, beforehand to save time—for example, 10- or 20-pound breaching charges of C4, expedient-shaped charges in No.10 cans.
 - Use C4 to breach hard targets (masonry construction).
 - Do not take chances.
 - Do not divide responsibility for explosive work.
 - Do not mix explosives and detonators.
 - Do not carry explosives and caps together.

POUNDS OF EXPLOSIVE	SAFE DISTANCE IN METERS	POUNDS OF EXPLOSIVE	SAFE DISTANCE IN METERS
1 to 29	300	150	514
30	311	175	560
35	327	200	585
40	342	225	609
45	356	250	630
50	369	275	651
60	392	300	670
70	413	325	688
80	431	350	705
90	449	375	722
100	465	400	737
125	500	425 and over	750

NOTE: These distances will be modified in combat when troops are in other buildings, around corners, or behind intervening walls.

Table C-2. Minimum safe distances for personnel in the open.