

PROTECTION IN THE NUCLEAR AGE

THE FEDERAL CIVIL DEFENSE ACT OF 1950, AS AMENDED
Public Law 920-81st Congress
(50 usc App. 2251-2297)

It is the policy and intent of Congress to provide a system of civil defense for the protection of life and property in the United States.... The term "civil defense" means all those activities and measures designed to minimize the effects upon the civilian population caused by an attack upon the United States. The Administrator is authorized, in order to carry out the above-mentioned purposes, to ... publicly disseminate appropriate civil defense Information by all appropriate means.

Federal Emergency Management Agency
Washington, D.C. 20472

FOREWORD

The primary goal of the Federal Emergency Management Agency (FEMA) is to protect lives and reduce property loss from disasters and emergencies. To accomplish this, FEMA works with state and local governments to help them deliver better, more effective emergency management services across the whole spectrum of hazards—both natural and man-made.

Regardless of the type, size, or severity of an emergency, certain basic capabilities are needed for an effective response: evacuation, shelter, communications, direction and control, continuity of government, resource management, law and order, and food and medical supplies. FEMA developed its Integrated Emergency Management System to focus efforts on building these and other generic capabilities needed to cope with a wide range of hazards.

This publication provides basic preparedness guidance combined with specific measures useful in national security emergencies.

TABLE OF CONTENTS

Introduction	iii
Part 1: THE EFFECTS OF NUCLEAR WEAPONS	1
Part 2: WARNING	9
Part 3: POPULATION PROTECTION	12
Part 4: SHELTER LIVING	23
Appendix A: PERMANENT SHELTERS	31
Appendix B: EXPEDIENT FALLOUT SHELTER— ABOVE-GROUND DOOR-COVERED SHELTER	32
Appendix C: EXPEDIENT FALLOUT SHELTER— DOOR-COVERED TRENCH SHELTER	34
Appendix D: EXPEDIENT FALLOUT SHELTER— LOG-COVERED TRENCH SHELTER	37

INTRODUCTION

Most counties and cities throughout the country have civil preparedness programs to reduce the loss of life and property in the event of major emergencies. These emergencies can range from natural disasters such as hurricanes, floods, or tornadoes to man-made emergencies like hazardous materials spills, fire, or nuclear attack.

This booklet focuses on the ultimate disaster—nuclear attack. It discusses what individuals and families can do to improve their chances for survival in the event of a nuclear attack on the United States. Basic information is provided on the physical effects of a nuclear detonation, attack warning signals, and what to do before, during, and after an attack.

Much has been done to address emergency needs unique to nuclear attack. Public fallout shelter space has been identified for millions. In addition, some warning and communications networks have been “hardened” against blast and electronic disruptions, preparations have been made to measure fallout radiation, and many local emergency services personnel have been trained in use of radiation detection instruments and other emergency skills.

This booklet contains general information applicable anywhere in the United States to supplement specific local instructions. Local plans are more detailed and are adapted to particular communities. When local instructions differ from this general guidance, the local instructions should always take precedence.

For more information on plans for your community, contact your local or state emergency management (civil defense) office.

PART 1

THE EFFECTS OF NUCLEAR WEAPONS

Understanding the major effects of a nuclear detonation can help people better prepare themselves if an attack should occur. When a nuclear weapon is detonated, the main effects produced are intense light (flash), heat, blast, and radiation. The strength of these effects depends on the size and type of the weapon; the weather conditions (sunny or rainy, windy or still); the terrain (flat ground or hilly); and the height of the explosion (high in the air or near the ground). In addition, explosions that are on or close to the ground create large quantities of dangerous radioactive fallout particles. Most of these fall to earth during the first 24 hours.

Figure 1 illustrates the damage that a one-megaton weapon* would cause if exploded on the ground in a populated area.

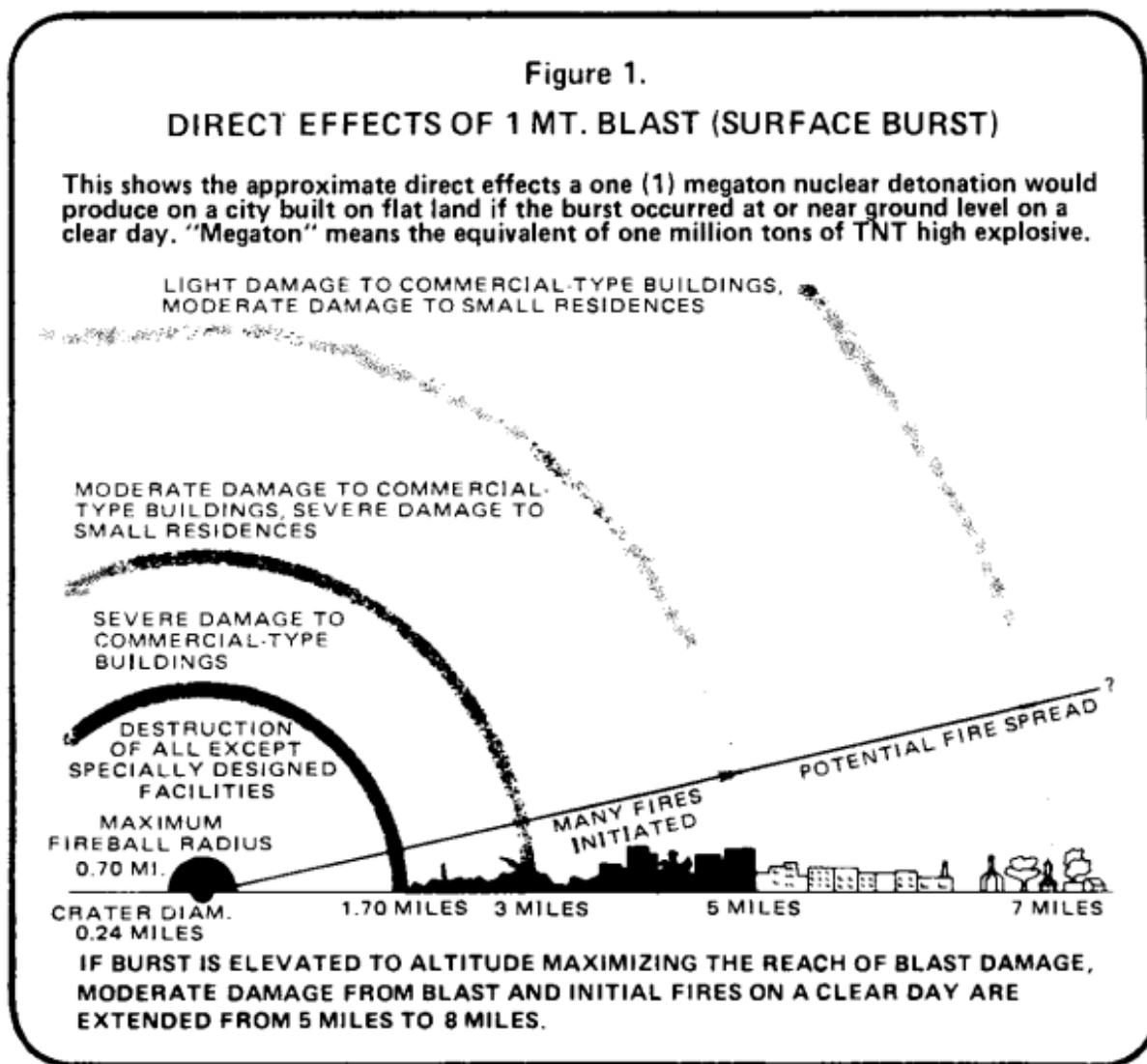

*Most weapons currently stockpiled are one megaton or less.

What Would Happen to People

In a nuclear attack, most people within a few miles of an exploding weapon would be killed or seriously injured by the blast, heat, or initial radiation. People in the lighter damage areas—as indicated in Figure 1—would be endangered both by blast and heat effects. However, millions of people are located away from potential targets. For them, as well as for survivors in the lighter damage areas, radioactive fallout would be the main danger. What would happen to people in a nationwide attack, therefore, would depend primarily on their proximity to a nuclear explosion.

What is Electromagnetic Pulse?

An additional effect that can be created by a nuclear detonation is called electromagnetic pulse, or EMP. A nuclear weapon exploding just above the earth's atmosphere could damage electrical and electronic equipment for thousands of miles. (EMP has no direct effect on living things.)

EMP is electrical in nature and is roughly similar to the effects of a nearby lightning stroke on electrical or electronic equipment. However, EMP is stronger, faster, and briefer than lightning. EMP charges are collected by typical conductors of electricity, like cables, antennas, power lines, or buried pipes, etc. Basically, anything electronic that is connected to its power source (except batteries) or to an antenna (except one 30 inches or less) at the time of a high altitude nuclear detonation could be affected. The damage could range from minor interruption of function to actual burnout of components.

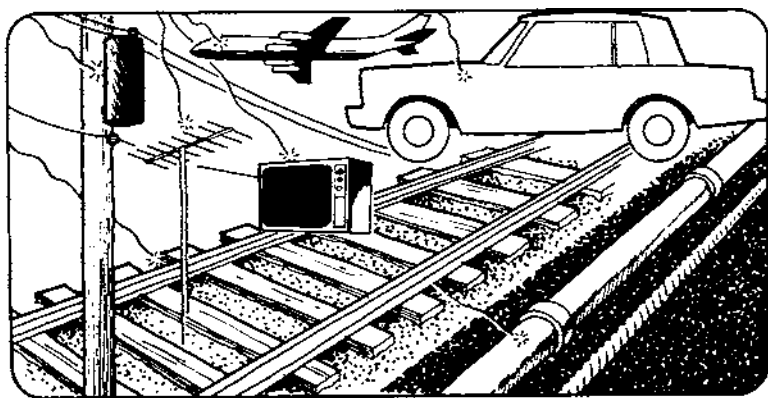

Equipment with solid state devices, such as televisions, stereos, and computers, can be protected from EMP by disconnecting them from power lines, telephone lines, or antennas if nuclear attack seems likely. Battery-operated portable radios are not affected by EMP, nor are car radios if the antenna is down. But some cars with electronic ignitions might be disabled by EMP.

What is Fallout?

When a nuclear weapon explodes on or near the ground, great quantities of pulverized earth and other debris are sucked up into the nuclear cloud. The radioactive gases created by the explosion condense on and into this debris, producing radioactive particles known as fallout.

There is no way of predicting what areas would be affected by fallout or how soon the particles would fall back to earth at a particular location. The amount of fallout would depend on the number and size of weapons and whether they explode near the ground or in the air. The distribution of fallout would

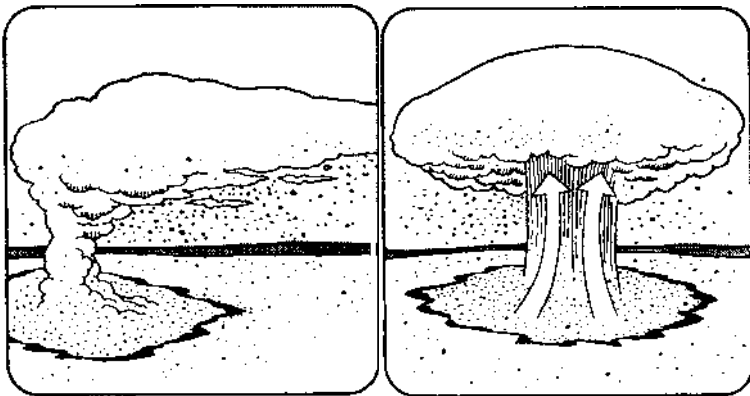

be determined by wind currents and other weather conditions. Wind currents across the U.S. move generally from west to east, but actual wind patterns differ unpredictably from day to day. This makes it impossible to predict where fallout would be deposited from a particular attack.

An area could be affected not only by fallout from a nearby exploding weapon, but also by fallout from a weapon exploded many miles away. Areas close to a nuclear explosion might receive fallout within 15-30 minutes. It might take 5-10 hours or more for the particles to drift down on a community 100 to 200 miles away. No area in the U.S. could be sure of not getting fallout, and it is probable that some fallout particles would be deposited on most of the country.

Because fallout is actually dirt and other debris, the particles range in size. The largest particles are granular, like grains of sand or salt; the smallest are fine and dust-like.

At the time of explosion, all fallout particles are highly radioactive. The larger, heavier particles fall within 24 hours, and they are still very dangerous when they reach the ground. The smaller the particle, the longer it takes to fall. The smallest, dust-like particles may not fall back to earth for perhaps months or years, having lost much of their radioactivity while high in the atmosphere. (The rate at which fallout radioactivity decays is described in Figure 2.)

Fallout radioactivity can be detected only by special instruments which are already contained in the inventories of many state and local emergency services offices.

Protection from Fallout

For people who are not in areas threatened by blast and fire, but who need protection against fallout, there are three major factors to consider: distance, mass, and time.

The more DISTANCE between you and the fallout particles, the less radiation you will receive. In addition, you need a MASS of heavy, dense materials between you and the fallout particles. Materials like concrete, bricks, and earth absorb many of the gamma rays. Over TIME, the radioactivity in fallout loses its strength. Fallout radiation "decay" occurs relatively rapidly and is explained in Figure 2.

Figure 2

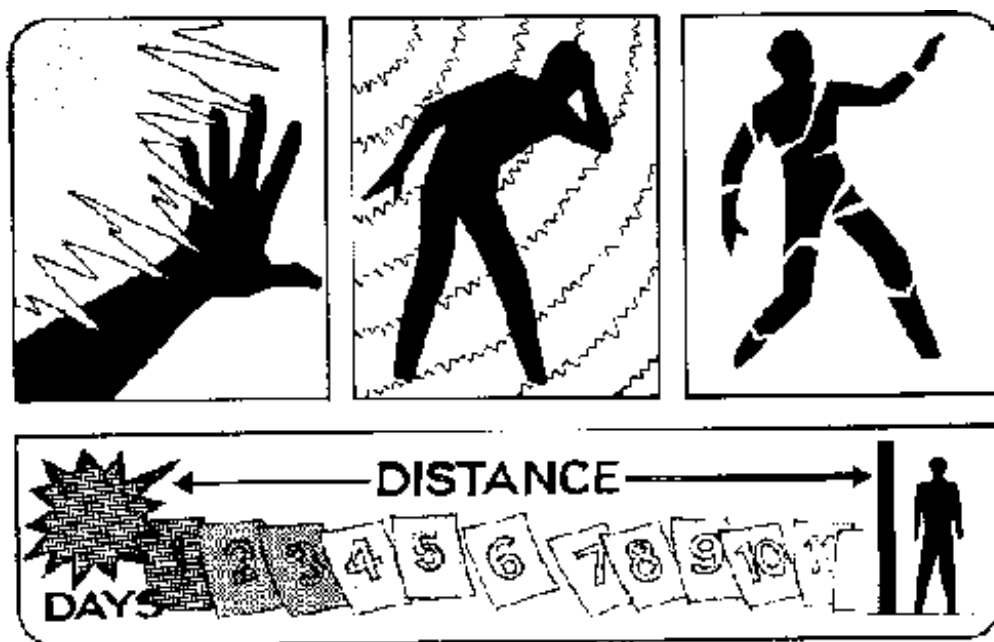

The decay of fallout radiation is expressed by the "seven-ten" rule. simply stated, this means that for every sevenfold increase in time after detonation, there is a tenfold decrease in the radiation rate. For example, if the radiation intensity one hour after detonation is 1,000 Roentgens (R)* per hour, after seven hours it will have decreased to one-tenth as much—or 100 R per hour. After the next sevenfold passage time (49 hours or approximately two days), the radiation level will have decreased to one-hundredth of the original rate, or be about 10 R per hour. The box below illustrates how, after about a two-week period, the level of radiation would be at one-thousandth of the level at one hour after detonation, or 1 R per hour.

Radiation exposure is measured in Roentgens (R).

Hours after Detonation	Rate of Decrease	Level of Radiation
1	--	1,000 R/hr
7	1/10	100 R/hr
49	1/100	10 R/hr
343	1/1000	1 R/hr

One way to protect yourself from fallout is by staying in a fallout shelter. As shown by Figure 2, the first few days after an attack would be the most dangerous time. How long people should stay in shelter would depend on how much fallout was deposited in their area. In areas receiving fallout, shelter stay times could range from a few days to as much as two weeks, or somewhat longer in limited areas.

Radiation Sickness

The invisible, radioactive rays given off by fallout particles cause radiation sickness—that is, physical and chemical damage to body cells. A large dose of radiation can cause serious illness or death. A smaller dose (or the same large dose received over a longer period of time) allows the body to repair itself.

Broadly speaking, radiation has a cumulative effect, acting much like a chemical poison. Like chemicals, a large single dose can cause death or severe sickness, depending on its size and the individual's susceptibility. Usually the effects of a given dose of radiation are more severe in the very young, the elderly, and people not in good health. On the other hand, people can be subjected to small daily doses over extended periods of time without causing serious illness, although there may be delayed consequences. Also, like illness from poison, one person cannot "catch" radiation sickness from another; it's not contagious.

There are three kinds of radiation given off by fallout: alpha, beta, and gamma. Alpha radiation is stopped by the outer skin layers. Beta radiation is more penetrating and may cause burns if unprotected skin is exposed to fresh fallout particles for a few hours. But of the three, gamma poses the greatest threat to life and is the most difficult to protect against. Gamma radiation can penetrate the entire body—like a strong x-ray—and cause damage in organs, blood, and bones. If exposed to enough gamma radiation, too many cells can be damaged to allow the body to recover.

Following are estimated short-term effects on humans after brief (a period of a few days to a week) whole-body exposure to gamma radiation.

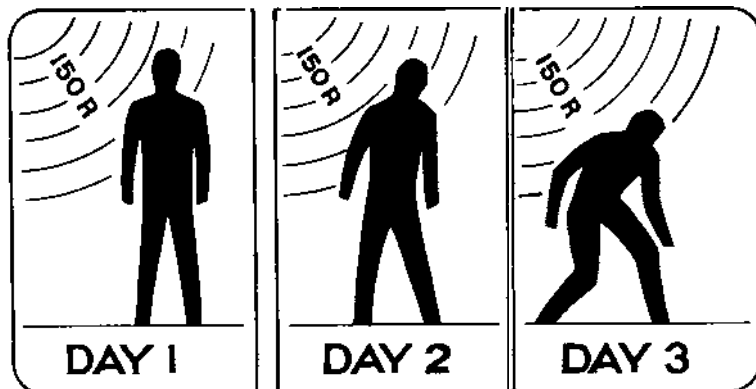

50-200 R exposure. Less than half of the people exposed to this much radiation suffer nausea and vomiting within 24 hours. Later, some people may tire easily, but otherwise there are no further symptoms. Less than 5 percent (1 out of 20) need medical care. Any deaths occurring after this much radiation exposure are probably due to complications arising from other medical problems such as infections and diseases, injuries from blast, or burns.

200-450 R exposure. More than half of the people exposed to 200-450 R in a brief period suffer nausea and vomiting and are ill for a few days. This illness is followed by a period of one to three weeks when there are few if any symptoms—a latent period. Then more than half experience loss of hair, and a moderately severe illness develops, often characterized by a sore throat. Radiation damage to the blood-forming organs results in a loss of white blood cells, increasing the chance of illness from infections. Most of the people in this group need medical care, but more than half will survive without treatment.

450-600 R exposure. Most of the people exposed to 450-600 R suffer severe nausea and vomiting and are very ill for several days. The latent period is shortened to one or two weeks. The main episode of illness that follows is characterized by extensive bleeding from the mouth, throat, and skin, as well as loss of hair. Infections such as sore throat, pneumonia, and enteritis (inflammation

of the small intestine) are common. People in this group need extensive medical care and hospitalization to survive. Fewer than half will survive in spite of the best care.

600 to over 1,000 R exposure. All the people in this group begin to suffer severe nausea and vomiting. Without medication, this condition can continue for several days or until death. Death can occur in less than two weeks without the appearance of bleeding or loss of hair. It is unlikely, even with extensive medical care, that many can survive.

Several thousand R exposure. Symptoms of rapidly progressing shock occur immediately after exposure. Death occurs in a few hours to a few days.

Symptoms of radiation sickness may not be noticed for several days. The early symptoms are lack of appetite, nausea, vomiting, fatigue, weakness, and headache. Later, the patient may have a sore mouth, loss of hair, bleeding gums, bleeding under the skin, and diarrhea. Not everyone who has radiation sickness shows all these symptoms, or shows them all at once. Even for people who survive early sickness, any exposure to fallout radiation could have effects that may not appear for months or years.

PART 2

WARNING

An enemy attack on the United States probably would be preceded by a period of international tension or crisis. This crisis period would alert citizens to the possibility of attack and should be used for emergency preparations.

How you receive warning of an attack would depend on where you were. You might hear the warning given on radio or television, or from the outdoor warning system in your city or town. Many communities have outdoor warning systems that use sirens, whistles, horns, or other devices. Although they've been installed mainly to warn citizens of enemy attack, some local governments also use these systems to alert people to natural disasters and other peacetime emergencies.

The Standard Warning Signals

Two standard emergency signals have been adopted by most communities:

The **ATTENTION** or **ALERT SIGNAL** is a 3- to 5-minute steady blast on sirens, whistles, horns, or other devices. In most places, this signal means the local government wants to broadcast important information. If you hear the attention or alert signal, turn on your radio or television and -stay tuned for news bulletins.



The **ATTACK WARNING SIGNAL** will be sounded only in case of enemy attack. The signal itself is a 3- to 5-minute wavering sound on sirens, or a series of short blasts on whistles, horns, or other devices, repeated as necessary. The **ATTACK WARNING SIGNAL** means that an actual attack against the United States has been detected and that immediate protective action is necessary.



If you hear the attack warning signal, go immediately to a public fallout shelter or to your home fallout shelter and stay there, unless instructed otherwise. If possible, keep a battery-powered radio with you, and listen for official information. Follow the instructions given.

Sirens are tested regularly, often monthly, at a specific date and time. The test is a 90-second blast or a 90-second rising and falling tone.

Set Up a “Warning Watch”

Not all communities in the U.S. have outdoor warning systems. Or you may live too far from the signal to hear it— especially while you’re asleep.

If either of these cases applies to you, set up a “warning watch” during a period of international crisis. At least one person in your family should be listening to the radio or television at all times. If the United States is threatened by attack, most radio and television stations would be used to alert the public through the Emergency Broadcast System and carry official messages and instructions. Persons listening can alert other family members.

Set up your warning watch in shifts, taking turns with family members or neighbors. Alert any hearing-impaired people in your area to news updates.

Be Prepared Now

Find out now from your local civil defense office what warning signals are being used in your community, what they sound like, what they mean, and what actions you should take when you hear them. Check at least once a year for changes.

Also, identify fallout shelters in your area. Know which are closest to you and how to get to them. Have ready at least a two-week stock of water, food, and supplies to bring to shelter.

If There is a Nuclear Flash

It's possible that your first warning of an enemy attack might be the flash of a nuclear explosion. Or there may be a flash after a warning has been given and you are on your way to shelter.

Because the flash or fireball can blind you (even though you are too far away for the blast effects to harm you immediately), don't look at the flash.

Take cover immediately, preferably below ground level.



PART 3

POPULATION PROTECTION

Be INFORMED and Be PREPARED

These are the most important ways you can improve your chances for survival. First, read and understand available survival information. This publication contains survival information which can generally be used anywhere in the United States. Ask your local or state emergency management (civil defense) office for information unique to your locality.

Any attack on the United States probably would be preceded by a period of growing international tension and outbreaks of hostilities in other parts of the world.

Keep abreast of the news through the media. Listen for emergency information being broadcast or watch for printed information—like newspaper supplements—for your area. And be sure you know the signals used in your community to indicate alert and attack.

EVACUATION and SHELTER are the two basic ways people can protect themselves from the effects of a nuclear attack.

EVACUATION

If an international crisis threatens to result in a nuclear attack on the United States, people living in likely target areas may be advised to evacuate. These are generally metropolitan areas of 50,000 or more population or places that have significant military, industrial, or economic importance. Designating a place as a "risk" area does not mean that it will be attacked; it does indicate a greater potential for attack.

Evacuation planning has been in progress for several years in many parts of the country. These plans could be used not only under the threat of attack, but also for other emergencies like floods, hurricanes, or hazardous materials incidents. Local authorities are responsible for such planning because

they are familiar with local factors affecting evacuation. To find out about evacuation plans for your area, contact your local emergency management (civil defense) office.

In a period of growing international tension, you would have time to take a few preparedness measures which would make an evacuation easier:

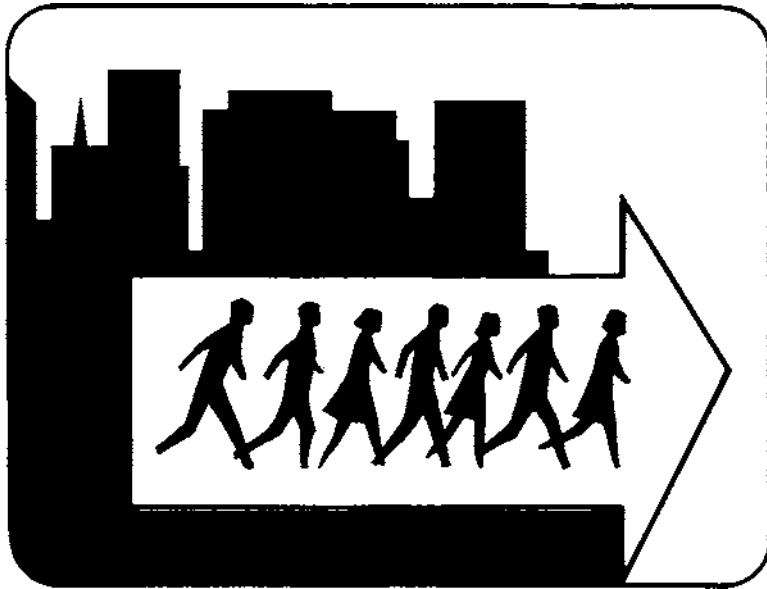

- Assemble a two-week supply of food (canned foods and nonperishable items) and drinking water in closed containers.
- Gather an ample supply of special foods or medicines needed.
- Collect all important papers and package them, preferably in plastic wrappers, in a metal container (tool or fishing tackle box, etc.).
- Check your home for security. See that all locks are secure. Store valuables to be left behind in a safe place.
- Be sure to have enough gasoline in your car. If possible, take tools to help improvise fallout shelter.
- Go over instructions with your family so that you all understand what to do.

The following is a suggested checklist of items you may want to take with you when evacuating, depending on how you are traveling and whether you plan to stay in a public or private shelter.

Food and Utensils

- Water
- Food (Take all the food you can carry, particularly canned or dried
- Food requiring little preparation.)
- Special foods (for diabetics, babies)
- Thermos jug or plastic bottles
- Bottle and can opener
- Eating utensils
- Plastic or paper plates and cups
- Plastic and paper bags

Personal Safety, Sanitation, and Medical Supplies

- Battery-operated (transistor) radios, extra batteries
- Flashlight, with extra batteries
- Candles and matches
- Plastic drop cloth or sheeting
- Soap
- Shaving articles
- Sanitary napkins (or tampons)
- Detergent
- Towels and washcloths
- Toilet paper
- Emergency toilet (bucket and plastic bags)
- Garbage can
- Newspapers

- First aid kit and manual
- Special medication (insulin, heart tablets, etc.)
- Toothbrush and toothpaste

Clothing and Bedding

- Work gloves
- Work clothes
- Extra underclothing
- Outerwear (depending on season)
- Rain garments
- Extra pair of shoes
- Extra socks or stockings
- Sleeping bags and or blankets

Page 14

Tools for Constructing Fallout Protection

- Pick axe
- Shovel
- Saw
- Hammer
- Broom
- Axe
- Crowbar
- Nails and screws
- Screwdriver
- Wrenches and pliers
- Roll of wire

Baby Supplies

- Diapers
- Bottles and nipples
- Milk or formula
- Powder, oil, etc.
- Clothing

If an evacuation is advised, follow your local authorities instructions. They will tell you where to go for greater safety.

SHELTER

There are two kinds of shelters—blast and fallout. Depending on its strength, a blast shelter offers some protection against blast pressure, initial radiation, heat, and fire. However, even a blast shelter would not withstand a direct hit. If you live in a likely target area, you should plan to evacuate to a safer place.

If you live in a small town or rural area away from large cities or major military or industrial centers, the chances are you're not going to be threatened by blast, but by radioactive fallout from an attack. In such a place, a fallout shelter can give you protection.

A fallout shelter is any space that is surrounded by enough shielding material—which is any substance with enough weight and mass to absorb and deflect fallout's radiation—to protect those inside from the harmful radioactive particles outside. The thicker, heavier, or denser the shielding material is, the more protection it offers.

If you are advised to take shelter, you have two options: go to a nearby public shelter or take the best available shelter in your home.

Public Fallout Shelters

Existing public shelters are fallout shelters; they will not protect you against blast. They are located in larger public buildings and are marked with the standard yellow-and-black fallout shelter sign. Shelter can also be found in some subways, tunnels, basements, or the center, windowless areas of middle floors in high-rise buildings.

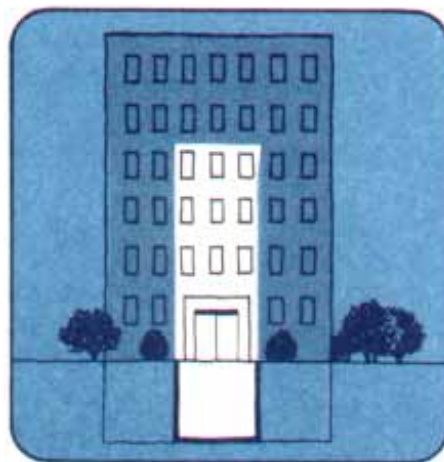

Find out now the locations of public fallout shelters in your community. If no designations have been made, learn the locations of potential shelters near your home, work, school, or any other place where you spend considerable time. This advice is for all family members. Children and the disabled or elderly especially should be given clear instructions on where to find a fallout shelter and on what other actions they should take in an attack situation.

Home Fallout Shelters

In many places— especially suburban and rural areas—there are few public shelters. If there is no public shelter nearby, you may want to build a home fallout shelter.

A basement, or any underground area, is the best place to build a fallout shelter. Basements in some homes are usable as family fallout shelters without major changes, especially if the house has two or more stories and its basement is below ground. If your home basement—or one corner of it—is below ground, build your fallout shelter there.

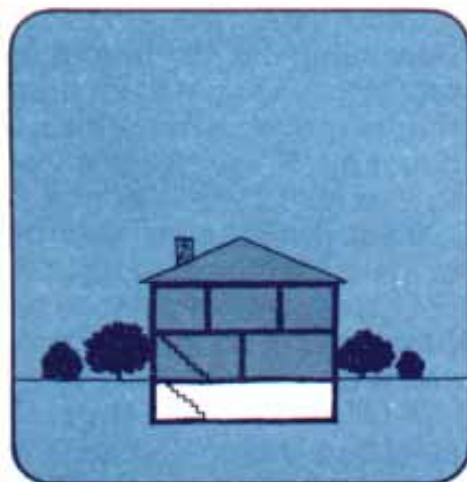

However, most basements need some improvement in order to provide enough protection against fallout. Many improvements can be made with moderate effort and at low cost.

You can build a permanent shelter in your basement that can be used for storage or other useful purposes in non-emergency periods. The shelter should be located in the corner of your basement that is most below ground level. The higher your basement is above ground level, the thicker the walls and roof of the shelter should be, since your regular basement walls and ceiling can offer only limited protection against fallout's radiation. If the ceiling of the shelter itself is higher than the outside ground level, you can increase your basement shelter's fallout protection by adding shielding material to the outside, exposed basement wall where the shelter is located. For example, an earth-filled planter can be built against the outside basement wall.

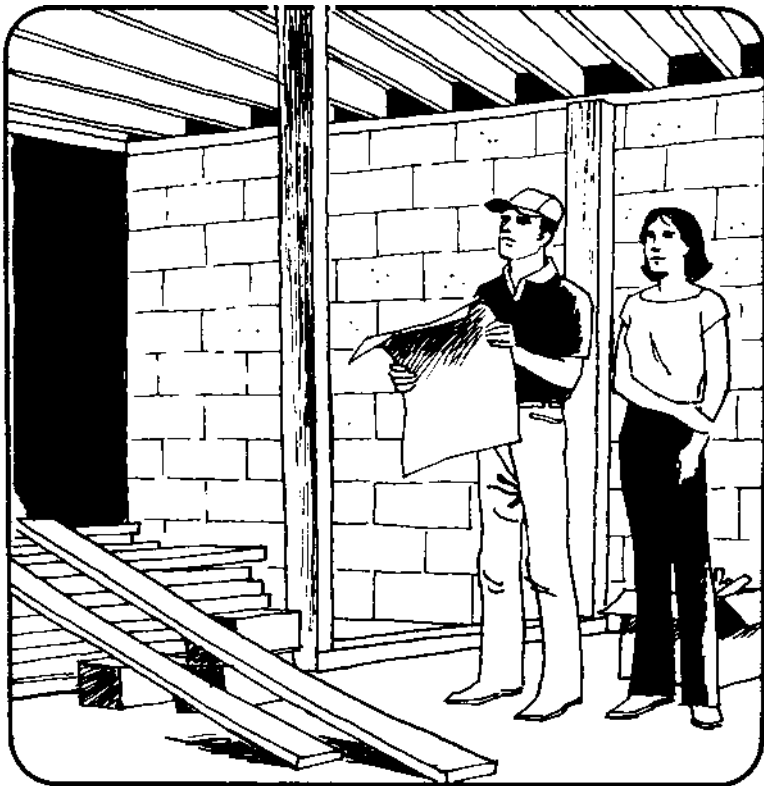

Plans for home basement and outdoor permanent shelters (both fallout and blast) are listed in Appendix A.

If an attack is imminent and you have no permanent shelter—and time does not permit traveling to one—you can still improvise one.

Shielding Material

Whether you are building a permanent shelter or improvising one, the more shielding material you use, the more protection you will have against fallout radiation. Concrete, bricks, earth, and sand are some of the materials that are dense or heavy enough to provide fallout protection. For comparative purposes, 4 inches of concrete gives the same shielding density as:

- 5 to 6 inches of bricks
- 6 inches of sand or gravel
- 7 inches of earth
- 8 inches of hollow concrete blocks (6 inches, if filled with sand)
- 10 inches of water
- 14 inches of books or magazines
- 18 inches of wood

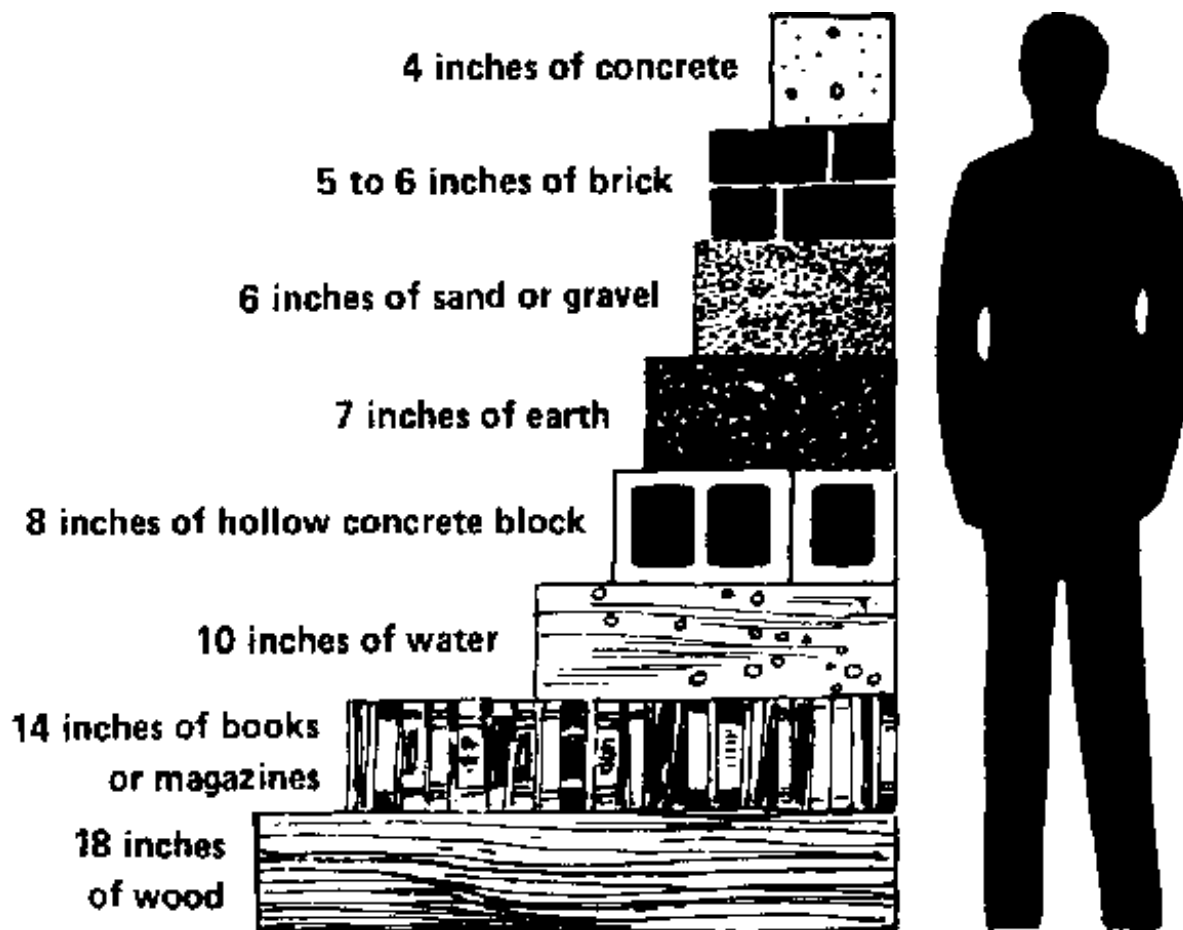

Precise building instructions and supplies needed are contained in the plans for permanent shelters. For improvised shelter, you can use materials likely to be available around your home, like:

- House doors—especially heavy outside doors. (If you use hollow core doors, form a double layer.)
- Dressers and chests. (Fill drawers with sand or earth after they're in position, so they won't be too heavy to carry or collapse while being carried.)
- Trunks, boxes, and cartons. (Fill them with sand or earth after they're positioned.)
- Filled bookcases.
- Books, magazines, and stacks of firewood or lumber.
- Large appliances, such as washers and dryers.
- Flagstones from outside walks and patios.

Types of Expedient Shelters

You can build one type of expedient shelter by setting up a large, sturdy table or workbench in the corner of your basement that is most below ground level. Place on it as much shielding as it will hold without collapsing. Then put as much shielding material around the table as possible, up as high as the table top.

Once everyone is inside the shelter, block the opening with additional shielding material. Listen to your radio for instructions on when you may be able to relocate to better shelter.



If you don't have a large table or workbench, or if you need more shelter space, use large appliances or furniture-like earth-filled dressers or chests-to form the "walls" of your shelter. For a "ceiling," use heavy, outside doors or reinforced hollow core doors. Pile as much shielding material on top of the doors as they will hold with reinforcing supports. Stack additional shielding material around the shelter "walls." When everyone is inside the shelter, block the opening with other shielding material.

You can use a below-ground storm cellar as an improvised fallout shelter, but additional shielding material may be required for adequate protection.

If the existing roof of the storm cellar is made of wood or any other light material, reinforce it with additional shielding material for overhead protection. Shoring with lumber or timbers may be necessary to support the added shielding weight. You can get better protection by baffling the entrance from the outside or by blocking the entrance from the inside with 8-inch concrete blocks or an equivalent thickness of earth, sandbags, or bricks after everyone is inside the shelter. Raise the outside door of the cellar now and then to knock off any fallout particles that may have collected on it.

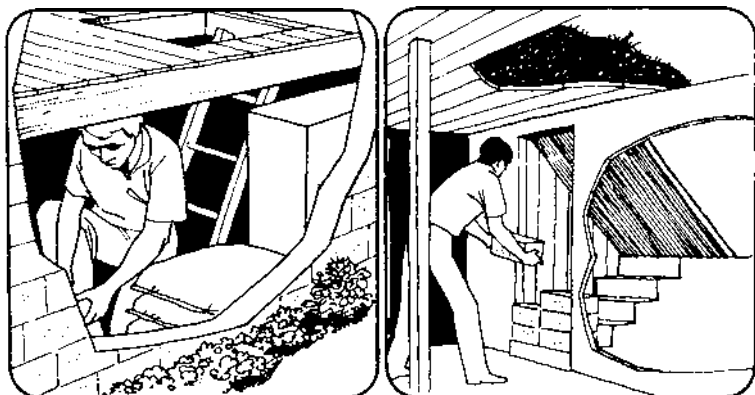

If your home has a crawl space between the first floor and the ground underneath and is set on foundation walls rather than on pillars, you may be able to improvise shelter protection for your family there.

Gain access to the crawl space through the floor or an outside foundation wall. (A trapdoor or other entry could be made now, before an emergency occurs.)

Select as your shelter's location the crawl space area that is under the center of the house, as far away from any outside foundation wall as possible. Put shielding material—preferably bricks or blocks, or containers filled with sand or earth—around the area from the ground level up to the first floor, to form the "walls" of the shelter. On the floor above, place additional shielding material to form the "roof" of your shelter. Shore the "roof" for extra support, if necessary. You may want to dig out your shelter area to make it deeper so you can stand erect or at least sit up in it.

If you have no basement, crawl space, or other underground shelter area, as a last resort you can improvise shelter outside. An expedient shelter can be "built" by excavating under a small portion of the house slab. Dig a trench alongside the house, preferably under an eave to help keep out rainwater. Once the bottom of the foundation wall is reached, dig out a space under the slab. This area can vary but should not extend back more than four feet from the outside edge of the foundation wall. Place support shoring under the slab, pile shielding material on top of the slab (inside the house) to improve overhead protection, and take refuge. A lean-to over the entrance, covered by shielding material and plastic sheeting, can help keep out rainwater and add to your protection.

If no better fallout protection is available, a boat with an enclosed cabin could be used. However, in addition to other emergency supplies, you would need a broom, bucket, or pump-and-hose to sweep off any fallout particles that might land on the boat.

The boat should be anchored or cruised slowly at least 200 feet offshore, where the water is at least five feet deep. This distance from shore would protect you from radioactive fallout particles that had fallen on the nearby land. A five-foot depth would absorb the radiation from particles falling into the water and settling on the bottom.

Stay in the boat as much as possible, going outside only to sweep or flush off any particles which have landed on the boat.

For more detailed expedient shelter plans, see Appendixes B-D.

Remember, any protection, although temporary, is better than none. Take cover wherever possible from the blast, fire, and initial radiation of a nuclear detonation. Listen for news reports on when it is safe to relocate to more permanent and protective shelter, and follow all instructions.

Fire Hazards

If you take refuge in a fallout shelter because an attack has occurred, take a few minutes to check your home (or building where you are located) for fire. Remember, you have a minimum of 15-30 minutes before fallout begins, so take the time to put out small fires. Stamp out any fires started in curtains or drapes and throw smoldering furniture out the door or window to help prevent a larger fire. When all ignitions are out, return to the shelter. You can reduce the potential for intense heat rays from a nuclear explosion starting fires in your home by closing doors, windows, and blinds.

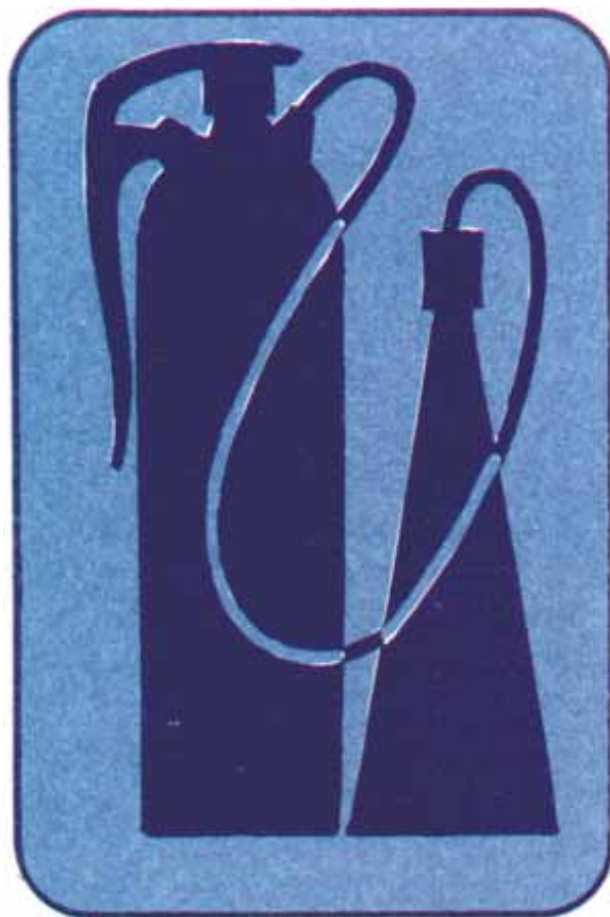

There are three basic ways to put out a fire:

- Take away its fuel.
- Take away its air (smother it).
- Cool it with water or fire-extinguishing chemicals.

SHELTER LIVING

People gathered in public and private fallout shelters after a nuclear attack should stay there until they are advised by authorities that it is safe to leave. This may be from a few days to as much as a week or two.

During the shelter period, they would need certain supplies and equipment to survive and to effectively deal with emergency situations that might arise in their shelters.

This section tells you what supplies and equipment to take if you go to a public fallout shelter and what items to keep on hand if you plan to use a home fallout shelter.

Public Shelter Management

Many public fallout shelters are located in large commercial buildings. Depending on what the building contains, there may be some food, water, and living supplies which people

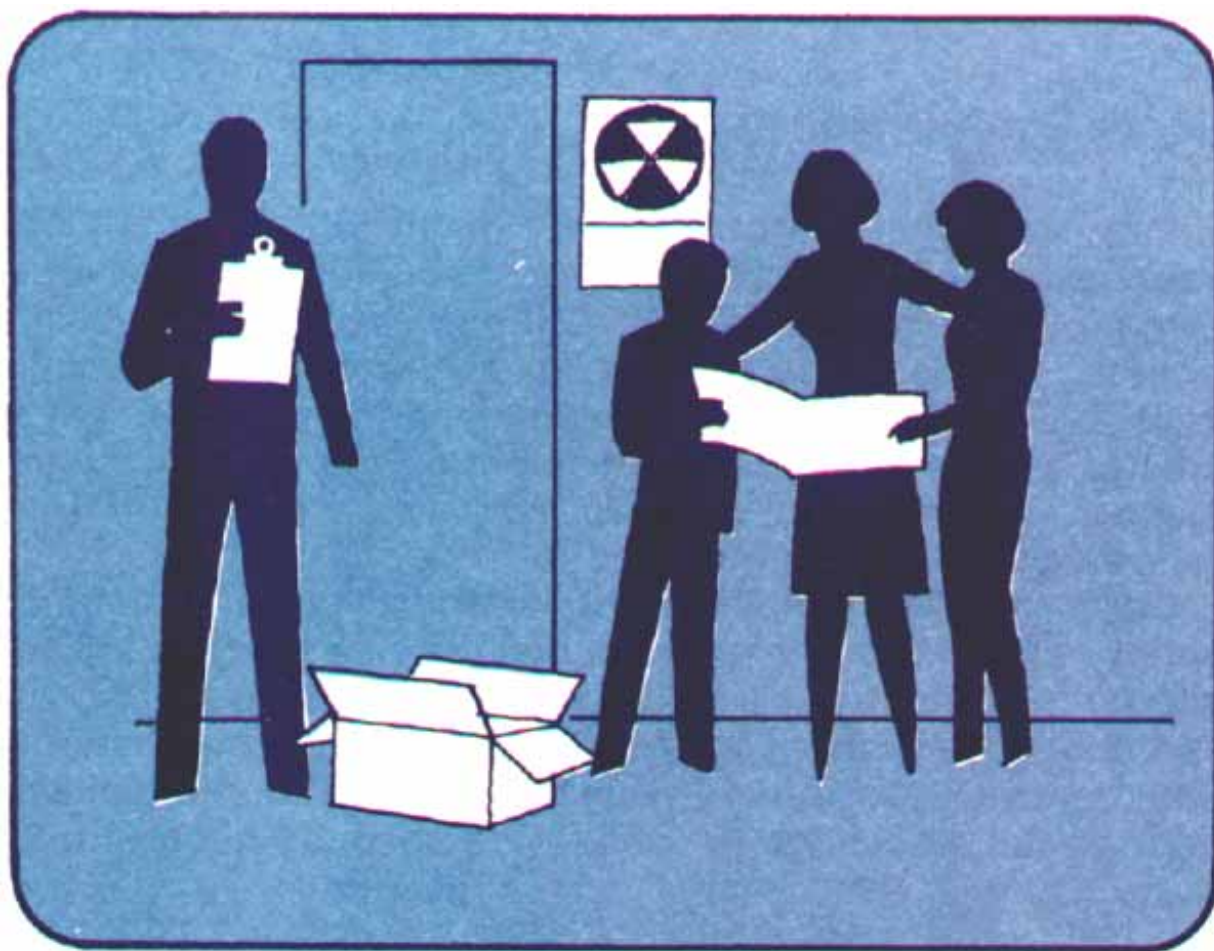

could take advantage of. If you are evacuating from one area to another to stay in a public shelter, take as much nonperishable food and drinking water as you can, any special foods or medications needed, a blanket for each family member, and a portable radio with extra batteries. (See suggested supplies for evacuation on pages 14-15.)

Water, Food, and Sanitation in a Public Shelter

At all times and under all conditions, human beings must have sufficient water, adequate food, and proper sanitation in order to stay alive and healthy. With people living in a shelter—even for a week or two—water and food may be scarce, and it may be difficult to maintain normal sanitary conditions. Water and food supplies have to be ‘managed’—that is, kept clean and used carefully by each person in the shelter. Sanitation also has to be managed and controlled, perhaps by setting up emergency toilets and rules to ensure that they are used properly.

Many people have been trained as shelter managers, and in the event of attack, efforts would be made by local authorities to have trained shelter managers and radiation monitors in public fallout shelters. These people have been taught how to use special instruments to measure radiation and know about sanitation, ventilation, and making the best use of available water and food supplies.

Home Shelter Management

In a home shelter, you and your family will be largely on your own. You’ll have to take care of yourselves, solve your own problems, make your own living arrangements, subsist on the supplies you stocked, and find out for yourself (probably by listening to the radio) when it’s safe to leave shelter. In this situation, your most important tasks are to manage water and food supplies and maintain sanitation. The following guidance is intended to help you do this.

Gather the items your family will need for an extended shelter stay. All of these items need not be stocked in the shelter but can be stored elsewhere in the house as long as you can move them quickly to the shelter area in a time of emergency. A few items—water, food, sanitation supplies, and special medicines or foods—are absolute necessities.

In addition, there are other important items that may be needed. Here is a list of them, both essential and desirable.

WATER. Water is even more important than food. Each person will need at least one quart of water per day; some may need more. Store it in plastic containers or in bottles or cans with tight stoppers. Part of your water supply might be "trapped" in the pipes or hot water tank of your home plumbing system, and part of it might be in the form of bottled or canned beverages, fruit or vegetable juices, or milk. A water-purifying agent (either water-purifying tablets, 2 percent tincture of iodine, or liquid household chlorine bleach with hypo-chlorite as its only active ingredient) should also be stored in case you need to purify any cloudy or "suspicious" water that may contain bacteria. (Also see page 28.)



FOOD. Keep enough food on hand to feed all shelter occupants for an extended period including special foods needed for infants, elderly persons, and those on limited diets. Most people in shelter can get along on about half as much as usual and can survive without food for several days if necessary. If possible, store canned or sealed-package foods, preferably those not requiring refrigeration or cooking.



SANITATION SUPPLIES. Since you may not be able to use your bathroom during the emergency, keep these sanitation supplies on hand: a metal container with a tight-fitting lid to use as an emergency toilet, one or two large garbage cans with covers (for human wastes and garbage), plastic bags to line the toilet container, disinfectant, toilet paper, soap, wash cloths and towels, a pail or basin, and sanitary napkins. Although desirable, keeping clean is not essential to survival. Water should be saved mainly for drinking and for medical emergencies.



MEDICINES AND FIRST AID SUPPLIES.

Include medicines taken regularly or likely to be needed by family members. First aid supplies should include all those found in a good first aid kit (bandages, antiseptics, etc.), plus all the items normally kept in a well-stocked home medicine chest (aspirin, thermometer, baking soda, petroleum jelly, etc.). You should also have a good first aid handbook.



INFANT SUPPLIES. Families with babies should keep on hand at least a two-week stock of infant supplies such as canned milk or baby formula, disposable diapers, bottles and nipples, rubber sheeting, blankets, and baby clothing. Because water for washing might be limited, baby clothing and bedding should be stored in larger-than-normal quantities.



COOKING AND EATING UTENSILS.

Emergency supplies should include pots, pans, knives, forks, spoons, plates, cups, napkins, paper towels, measuring cup, bottle opener, can opener, and pocket knife. If possible, disposable items should be stored. A heat source might also be helpful, such as a camp stove or canned-heat stove, since there would probably be no electric power. If a stove is used indoors, however, adequate ventilation is essential. (Do not use charcoal for heating or cooking.)



BEDDING. Blankets are the most important items of bedding needed in a shelter, but occupants probably would be more comfortable if they also have pillows, sheets, and air mattresses or sleeping bags.



FIRE-FIGHTING EQUIPMENT. Simple fire-fighting tools, and knowledge of how to use them, are useful. A hand-pumped fire extinguisher of the inexpensive, 5-gallon, water type is preferred. Carbon tetrachloride and other vaporizing-liquid type extinguishers are not recommended for use in small enclosed spaces, because of the danger from toxic fumes. Other fire equipment for home use includes buckets filled with sand, a ladder, and a garden hose.



GENERAL EQUIPMENT AND TOOLS.

The essential items in this category are a battery-powered radio and a flashlight or lantern, with spare batteries. The radio may be your only link with the outside world, and you may have to depend on it for all your information and instructions, especially for advice on when to leave shelter.



CLOTHING. Several changes of clean clothing—especially undergarments and socks—should be ready for shelter use in case water for washing is scarce.

Other useful items include: matches, candles, a shovel, broom, axe, crowbar, kerosene lantern, short rubber hose for siphoning, coil of half-inch rope at least 25 feet long, coil of wire, hammer, pliers, screwdriver, wrench, nails and screws.



Care and Use of Water Supplies

Each person's need for drinking water will vary, depending on age, physical condition, and time of year. The average person in a shelter will need at least one quart of water or other liquids to drink per day, but more would be better. Each person should be allowed to drink according to need. Studies have shown that nothing is gained by limiting drinking water below the amount demanded by the human body. Even with a limited supply, it's safer to drink as needed in the hope that the supply can be replenished if your shelter stay warrants it.

In addition to water stored in containers, there is usually other water available in most homes that is drinkable, like:

- Water and other liquids normally found in the kitchen, including ice cubes, milk, soft drinks, and fruit and vegetable juices;
- Water (20 to 60 gallons) in the hot water tank;
- Water in the flush tanks (not the bowls) of home toilets;
- Water in the pipes of your home plumbing system.

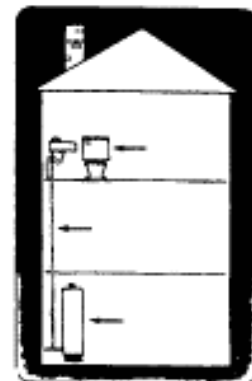

In a time of nuclear attack, local authorities may instruct householders to turn off the main water valves in their homes to avoid having water drain away in case of break and loss of pressure in the water mains. With the main valve in your house closed, all the pipes in the house would still be full of water. To use this water, turn on the faucet that is located at the highest point in your house, to let air into the system; and then draw water, as needed, from the faucet that is located at the lowest point in your house.

You should drink the water you know is uncontaminated first. If necessary, "suspicious" water, such as cloudy water from regular faucets or perhaps some muddy water from a nearby stream or pond, can be used after it has been purified. To purify water:

1. Strain the water through a paper towel or several thicknesses of clean cloth to remove dirt and fallout particles, if any. Or else let the water "settle" in a container for 24 hours, by which time most solid particles probably would have sunk to the bottom.

2. After the solid particles have been removed, boil the water if possible for 3 to 5 minutes, or add a water-purifying agent to it. This could be either: (a) water-purifying tablets, available at drug stores, or (b) two percent tincture of iodine, or (c) liquid chlorine household bleach, provided the label says that it contains hypochlorite as its active ingredient. For each gallon of water, use 4 water-purifying tablets, or 12 drops of tincture of iodine, or 8 drops of liquid chlorine bleach. If the water is cloudy, these amounts should be doubled.

Care and Use of Food Supplies

Food should be rationed carefully in a home shelter to make it last for at least a week. Half the normal intake should be adequate, except for children or pregnant women.

In a shelter, it is especially important to be sanitary in the storing, handling, and eating of food. Be sure to:

- keep all food in covered containers;
- keep cooking and eating utensils clean;
- keep all garbage in a closed container or dispose of it outside the home when it is safe to go outside. If possible, bury it. Avoid letting garbage or trash accumulate inside the shelter, both for fire and sanitation reasons.

Sanitation

In many home shelters, people would use emergency toilets until it was safe to leave shelter for brief periods of time. This kind of toilet, consisting of a watertight container with a snug-fitting cover, is necessary. It could be a garbage container, or a pail or bucket. If the container is small, a large container (also with a cover) should be available to empty the contents into for later disposal. If possible, both containers should be lined with plastic bags.

Every time the toilet is used a small amount of regular household disinfectant, such as creosol or chlorine bleach should be poured or sprinkled into it to keep down odors and germs. After each use, the lid should be put back on.

When the toilet container needs to be emptied and outside radiation levels permit, the contents should be buried in a hole one or two feet deep. This is to prevent the spread of disease.

When to Leave Shelter

The intensity of fallout radiation in your area is the major factor in determining when to leave shelter. If you see unusual quantities of gritty particles outside (on window ledges, sidewalks, cars, etc.) after an attack, you should assume that they are fallout particles and stay inside your shelter until you are told you may come out.

Special instruments are needed to detect fallout radiation and to measure its intensity. These instruments are part of the federal supplies provided to states for official use in monitoring radiation levels. Low-cost instruments to detect and measure fallout radiation are not now generally available for home shelter use. Therefore, you probably will have to depend on your local government to tell you when to leave shelter. This information probably will be given on the radio, which is one reason why you should keep a battery-powered radio on hand that works in your shelter areas.

As time passes, the radiation level will decline to a point where you can leave the shelter for short periods of time to perform emergency functions.

Personal and Community Preparedness

If the United States were attacked with nuclear weapons, people would be forced to rely on self-help and sharing among their families, friends, and neighbors. This guidance is intended to help you better understand the effects of nuclear weapons and provide general information on what you can do to increase your chances for survival. It is offered as a supplement to the instructions that would be issued by your local government in an attack situation.

For more information on your community's plans, contact your local or state emergency management (civil defense) office.

APPENDIX A

PERMANENT SHELTERS

The following detailed plans are available without charge from your local or state emergency services (civil defense) office or by writing to the Federal Emergency Management Agency, P.O. Box 8181, Washington, D.C. 20024, Attention: Shelter Plans. Please refer to title and number when ordering.

Home Shelter (H-i 2-1) An outside underground FALLOUT shelter.

Aboveground Home Shelter (H-12-2) An outside aboveground FALLOUT shelter for use in areas with a high water table.

Home Blast Shelter (H-12-3) An outside underground BLAST shelter.

Home Fallout Shelters (H-i 2-A and H-12-B) Modified ceiling shelters in basements.

Home Fallout Shelter (H-12-C) Small basement corner shelter.

Keep in mind that only the Home Blast Shelter (H-12-3) provides protection from blast; all the other plans listed provide fallout protection only.

Appendix B

Expedient Fallout Shelters

Above-Ground Door-Covered shelter

GENERAL INFORMATION

THE ABOVE-GROUND DOOR-COVERED SHELTER IS DESIGNED FOR AREAS WHERE BELOW-GROUND SHELTERS ARE IMPRACTICAL BECAUSE THE GROUNDWATER TABLE OR BEDROCK IS CLOSE TO THE GROUND SURFACE. THIS SHELTER CAN BE BUILT BY FOUR PERSONS WORKING A TOTAL OF 10 HOURS EACH.

READ AND STUDY ALL INSTRUCTIONS BEFORE STARTING TO BUILD. IF DOOR WIDTHS MEASURE LESS THAN 32 INCHES, USE A COMBINATION OF DOORS TO PROVIDE A MINIMUM OF 32 INCHES OF DOOR-WIDTH PER PERSON.

STEP 1

SELECT A SHELTER LOCATION WHERE THERE IS LITTLE OR NO CHANCE OF RAINWATER PONDING ON THE GROUND SURFACE. STAKE OUT SHELTER, REMOVE DOOR KNOBS. ALLOW 1 DOOR FOR EACH PERSON PLUS 1 DOOR FOR ENTRY/EXIT AT END. LIMIT IS 8 PERSONS PER SHELTER.

DOORS (32" WIDE) 1 PER PERSON PLUS 1 FOR EXIT/ENTRY

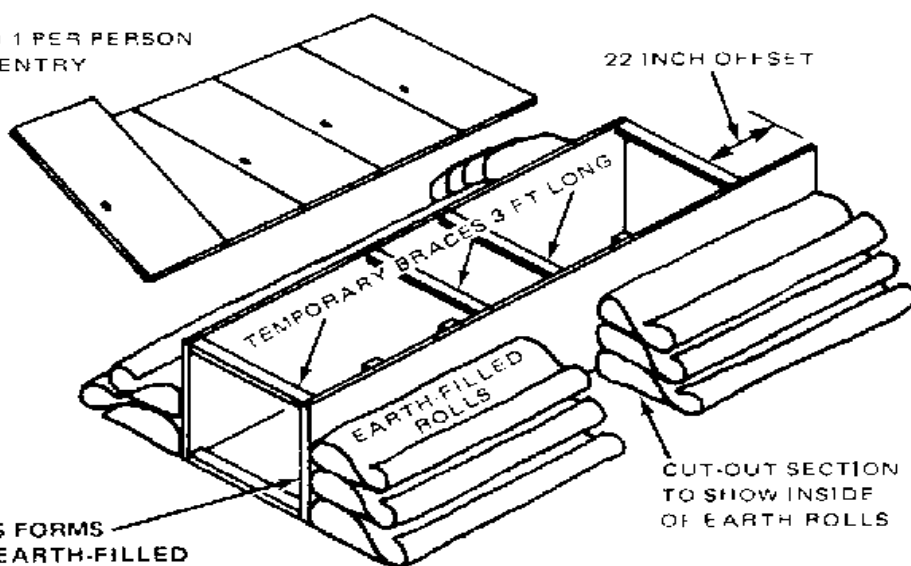

STEP 2

SET UP DOORS AS FORMS AROUND WHICH EARTH-FILLED ROLLS WILL BE PLACED. NAIL ONLY TOP BRACES. NAILS MUST BE REMOVED LATER. BRACE ALL CORNERS, CENTER, TOP AND BOTTOM OF EACH DOOR.

STEP 3

BEGIN TO PLACE EARTH-FILLED ROLLS AGAINST DOOR FORMS, TO FORM EARTH ROLLS, SEE EARTH-FILLED ROLL DETAIL BOTTOM OF PAGE.

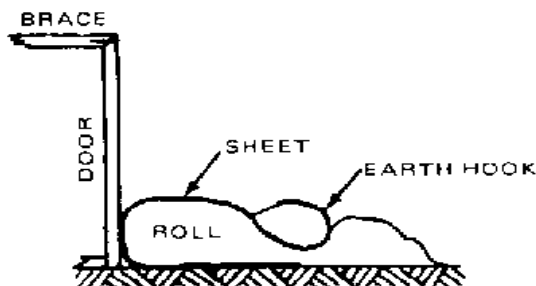

EARTH-FILLED ROLL DETAIL

1. PLACE 2 FT OF SHEET ON GROUND AND TEMPORARILY DRAPE REMAINDER OF SHEET ON DOOR
2. PLACE EARTH ON SHEET—SHAPE AS SHOWN
3. FOLD SHEET OVER SHAPED EARTH
4. PLACE EARTH ONTO SHEET AT NARROW TRENCH
5. FOLD SHEET TO FORM EARTH HOOK. HOOK WILL ANCHOR SHEET
6. REPEAT TO FORM NEXT EARTH-FILLED ROLL

Appendix B

STEP 4

DIG 14" DEEP, 36" WIDE TRENCH INSIDE SHELTER. EARTH CAN BE USED TO FORM SIDE EARTH-FILLED ROLLS. TRENCH CAN BE MADE UP TO 3 FEET DEEP IF CONDITIONS PERMIT.

STEP 5

MOUND EARTH AGAINST THE EARTH-FILLED ROLLS AS SHOWN. CONTINUE PLACING EARTH AND SHEETS TO FORM EARTH-FILLED ROLLS.

STEP 6

KEEP HEIGHT OF EARTH ABOUT EQUAL ON BOTH SIDEWALLS AS ROLLS ARE FORMED. AFTER SIDEWALLS HAVE REACHED PLANNED HEIGHT, REMOVE BRACES AND DOOR FORMS, USE SAME DOOR FORMS TO CONSTRUCT ENDWALLS WITH EARTH-FILLED ROLLS. PROVIDE EXIT/ENTRY AT END AS SHOWN.

STEP 7

REMOVE DOOR FORMS FROM ENDWALLS. POSITION ROOF DOORS IN THEIR FINAL POSITION. PLACE ENTRY FRAME FOR DOOR OVER ENTRY/EXIT. PLACE WATERPROOFING MATERIAL ON DOORS.

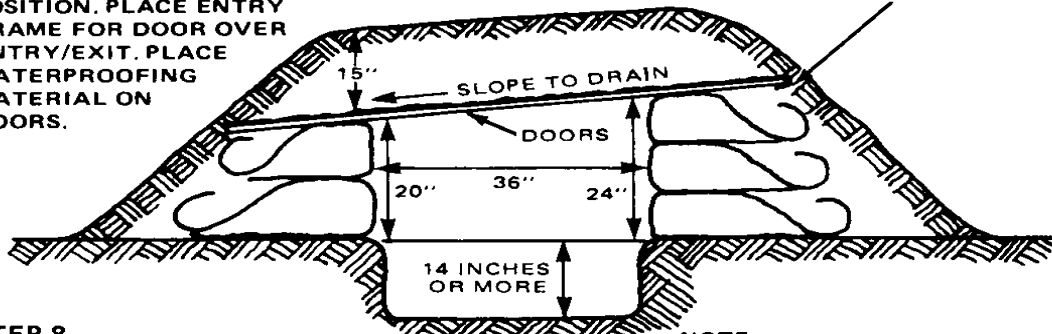

STEP 8

PLACE 15 INCHES OF EARTH ON TOP OF SHELTER. IN HOT WEATHER CONSTRUCT A SHELTER VENTILATION AIR PUMP.

TOOLS AND MATERIALS

1. Doors as indicated.
2. Pick or Mattock and Shovel.
3. Two Buckets or Large Cans to Carry Earth.
4. Tape Measure, Yardstick or T Ruler.
5. Saw, Axe or Hatchet.
6. Hammer and at Least 20 Nails—2½" Long.
7. At Least 4 Double Bed Sheets for Each Person to be Sheltered.
8. Pillowcases and Rainproofing Materials Such as Plastic or Polyethylene.
9. Work Gloves for Each Worker.
10. Lumber for use as Temporary Braces and for Entry/Exit Frame.

ENTRY/EXIT FRAME

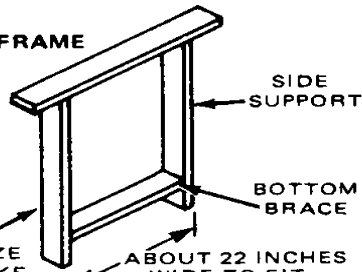

USE 2" X 4" BOARDS. SIZE TO FIT ENTRYWAY. MAKE AND INSTALL AFTER ENTRY IS COMPLETED.

FOLD WATERPROOFING MATERIAL UNDER HIGHER EDGE OF DOOR TO KEEP IT FROM SLIPPING.

NOTE:
IF TRENCHING IS IMPRACTICAL HEIGHTEN WALLS BY USING ADDITIONAL EARTH ROLLS.

**PLAN VIEW OF SHELTER (4 PERSON)
(LOOKING DOWN)**

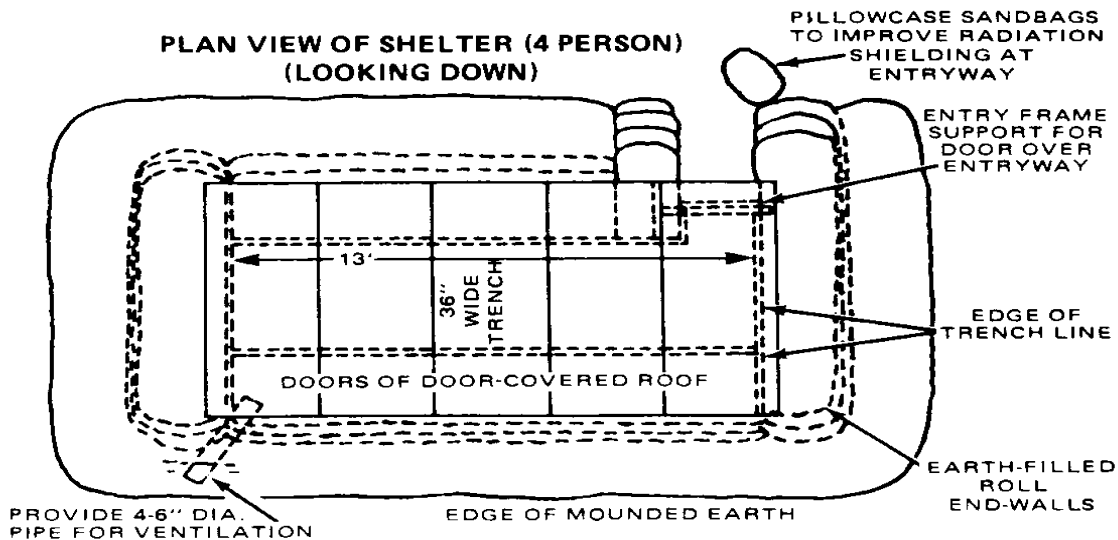

Appendix C

Expedient Fallout shelter Door-Covered Trench Shelter

GENERAL INFORMATION

THIS SHELTER IS DESIGNED FOR AREAS WHERE THERE IS A SHORTAGE OF SMALL TREES AND/OR BUILDING MATERIALS. THE DEPTH TO GROUND WATER AND ROCK MUST ALSO BE BELOW THE BOTTOM OF THE TRENCH. IN ADDITION, THE EARTH MUST BE SUFFICIENTLY FIRM AND STABLE SO THAT THE TRENCH WALLS WILL NOT COLLAPSE. THE SHELTER (3-PERSON CAPACITY) CAN BE CONSTRUCTED BY 3 PEOPLE WORKING AN APPROXIMATE TOTAL OF 12 HOURS EACH. READ AND STUDY ALL INSTRUCTIONS BEFORE BEGINNING TO BUILD.

STEP 1

SELECT A REASONABLY LEVEL SITE. LAY OUT THE SHELTER AS ILLUSTRATED BY LAYING DOORS SIDE BY SIDE TO DETERMINE THE SHELTER LENGTH. DOOR KNOBS SHOULD BE REMOVED.

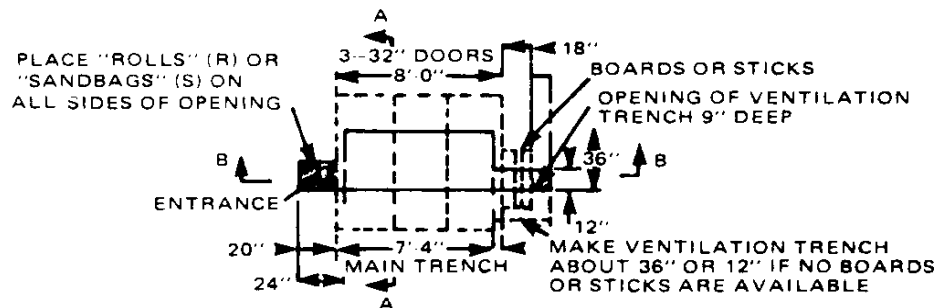

LAYOUT FOR 3-PERSON CAPACITY

STEP 2

EXCAVATE THE SHELTER TRENCH, ENTRYWAY AND VENTILATION TRENCH AS SHOWN. PILE THE EXCAVATED EARTH AT LEAST 3 FEET BEYOND THE TRENCH LIMITS SO THAT IT WILL NOT INTERFERE WITH THE LATER PLACEMENT OF DOORS OVER THE TRENCH.

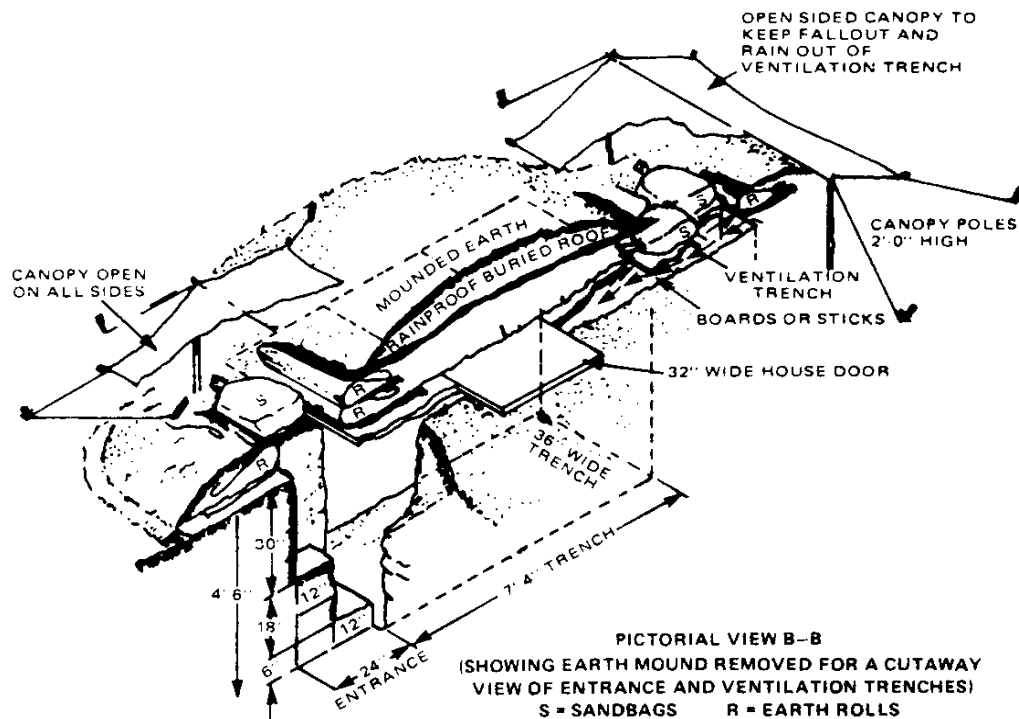

Appendix C

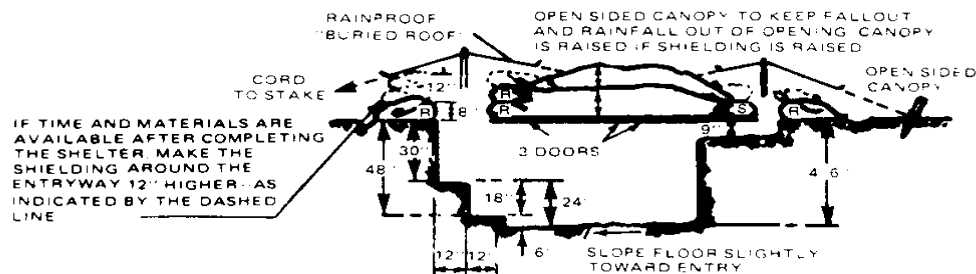

SECTION B-B

STEP 3

IF THERE ARE ADEQUATE SHEETS OR FABRIC AVAILABLE, LINE THE TRENCH WALLS WITH THEM. THEN PLACE DOORS OVER THE TRENCH.

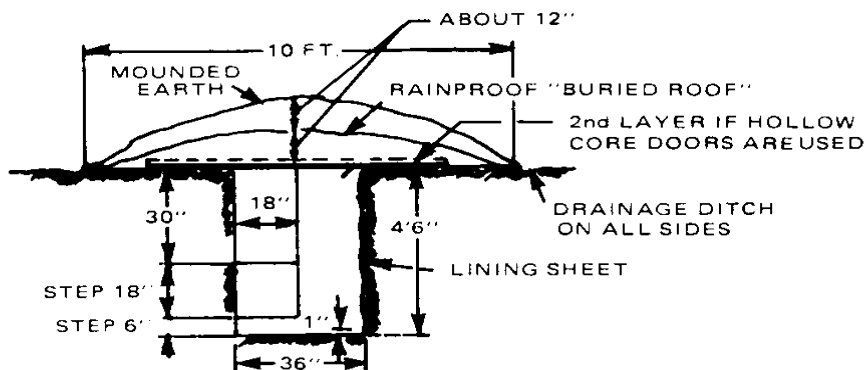

SECTION A-A

STEP 4

IN ORDER TO HOLD IN PLACE AN ADEQUATE AMOUNT OF EARTH ON TOP OF THE DOORS, CONSTRUCT EARTH "ROLLS" AROUND THE ENTRYWAY AS SHOWN. THE "ROLLS" WILL KEEP THE EARTH FILL IN PLACE. SEE HOW TO MAKE AN EARTH ROLL.

STEP 5

PLACE EARTH FILL AND THE WATERPROOFING MATERIAL OVER THE DOORS. PLACE SANDBAGS AS SHOWN ON THE ILLUSTRATIONS.

STEP 6

CONSTRUCT SHALLOW DRAINAGE DITCHES ON ALL SIDES AND PLACE CANOPIES OVER THE OPENINGS.

Appendix C

TOOLS AND MATERIALS

1. Doors (Interior solid or hollow-core)—1 full size (32" minimum width) for each person.
If doors measure less than 32" in width, use a combination of doors to provide the minimum width per person. **IF DOORS ARE HOLLOW CORE-USE TWO LAYERS.**
2. Pick and/or mattock.
3. Long-handled shovels and square-bladed shovel.
4. Rainproofing material—(e.g., plastic sheeting, canvas, plastic table covers, etc.) at least 25 square feet per person plus 2 pieces about 6 ft. by 6 ft. for use as canopies.
5. One bedsheet or the equivalent of 50 sq. ft. of cloth or plastic per person to line trench and make earth-filled rolls.
6. Two pillowcases per person to use as sandbags.
7. String or cord to tie canopies and sandbags.
8. Knife.
9. Several boards about 3 feet long.
10. Measuring tape and/or ruler.
11. Work gloves for each worker.
12. Hammer and hand saw.

HOW TO MAKE AN EARTH ROLL

1. SELECT A PIECE OF CLOTH OR PLASTIC AT LEAST AS STRONG AS A NEW BED SHEET, 2 FT. WIDER THAN THE SIDE OF THE OPENING TO BE PROTECTED, AND 5 FT. IN LENGTH.
2. PLACE 2 FT. OF THE LENGTH OF THE CLOTH ON THE GROUND, AS ILLUSTRATED.
3. WHILE USING BOTH HANDS TO HOLD UP 3 FT. OF THE LENGTH OF THE CLOTH AND WHILE PRESSING AGAINST THE CLOTH WITH YOUR BODY, HAVE ANOTHER PERSON SHOVEL EARTH ONTO AND AGAINST THE CLOTH.
4. WHILE STILL PULLING ON THE CLOTH, PLACE THE UPPER PART OVER THE EARTH THAT IS ON THE LOWER PART OF THE CLOTH.
5. COVER THE UPPER EDGE OF THE CLOTH, FORMING AN EARTH-FILLED "HOOK" IN THIS EDGE.

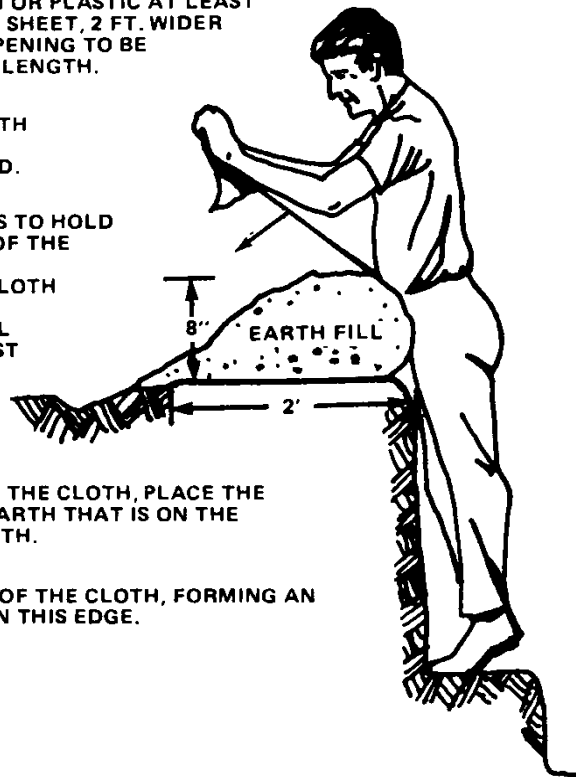

Appendix D

Expedient Fallout Shelter Log-Covered Trench Shelter

GENERAL INFORMATION

THIS SHELTER IS DESIGNED FOR AREAS WHERE THE DEPTH BELOW THE GROUND SURFACE TO HARD ROCK OR GROUNDWATER IS BELOW THE BOTTOM OF THE TRENCH. ALSO, THE EARTH MUST BE SUFFICIENTLY FIRM AND STABLE SO THAT THE TRENCH SIDEWALLS WILL NOT CAVE IN. IN ADDITION, ADEQUATE SMALL TREES THAT CAN BE CUT FOR LOGS MUST BE AVAILABLE IN THE IMMEDIATE AREA. THE SHELTER (4-PERSON CAPACITY) CAN BE BUILT BY 4 PEOPLE WORKING A TOTAL OF 12 HOURS EACH. AFTER INITIAL COMPLETION, THE SHELTER CAN BE ENLARGED TO A WIDTH OF 5 FT. - 6 IN. AND DEEPENED TO 6 FT. HOWEVER, 9-FT LOGS MUST BE USED IN PLACE OF 7-FT LOGS AND THE BURIED ROOF MUST BE LARGE ENOUGH TO COVER THE WIDENED SHELTER DURING THE INITIAL CONSTRUCTION.

STEP 1

CLEAR AREA OF BRUSH AND TALL GRASS. LAYOUT SHELTER AS SHOWN BELOW.

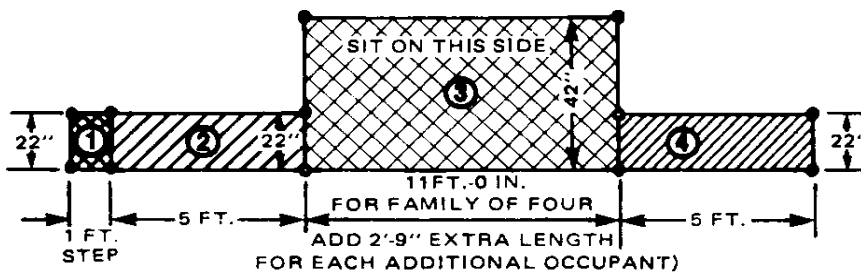

LEGEND

- = WOOD OR METAL STAKE
- ENTRANCE STEP
2'-6" DEEP
- ENTRANCE TRENCH
4'-0" DEEP
- SHELTER ROOM
4'-6" DEEP
- VENTILATION TRENCH
24" DEEP

STEP 2

BEGIN EXCAVATING THE TRENCH. PLACE EXCAVATED EARTH AT LEAST 3 FEET BEYOND THE EDGE OF TRENCH SO THAT THE ROOF LOGS CAN LATER BE PLACED OVER THE TRENCH.

STEP 3

AS THE TRENCH EXCAVATION PROGRESSES, WORKERS SHOULD BEGIN CUTTING LOGS TO THE LENGTH AND SIZE AS SHOWN ON THE ILLUSTRATIONS.

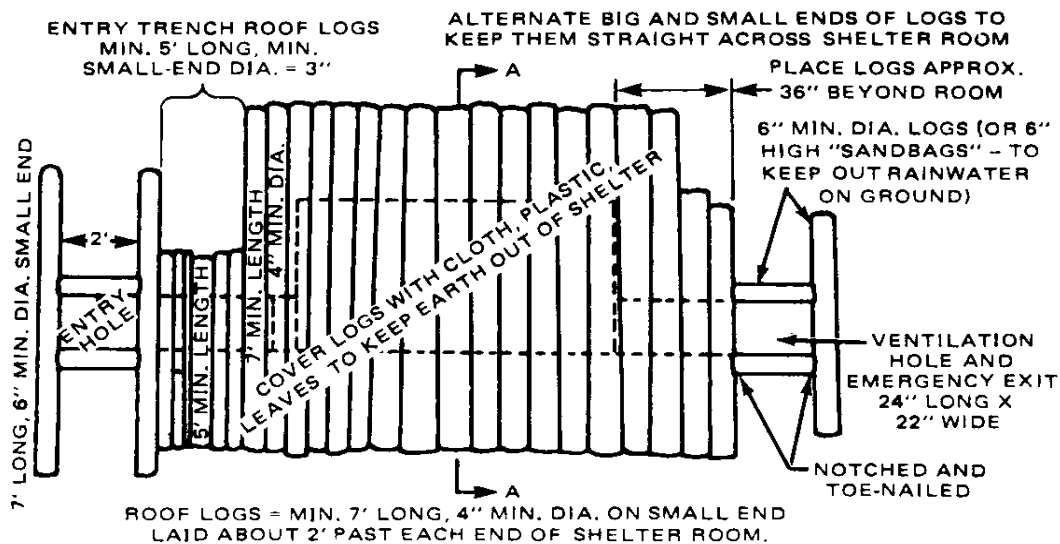

PLAN VIEW OF TOP OF SHELTER

Appendix D

STEP 4

PLACE LOGS OVER TRENCH. POSITION TIES FOR BED SHEET CHAIRS OR HAMMOCKS. PLACE NEWSPAPER OR OTHER MATERIAL AS INDICATED OVER LOGS. PLACE EARTH FILL AND BURIED ROOF.

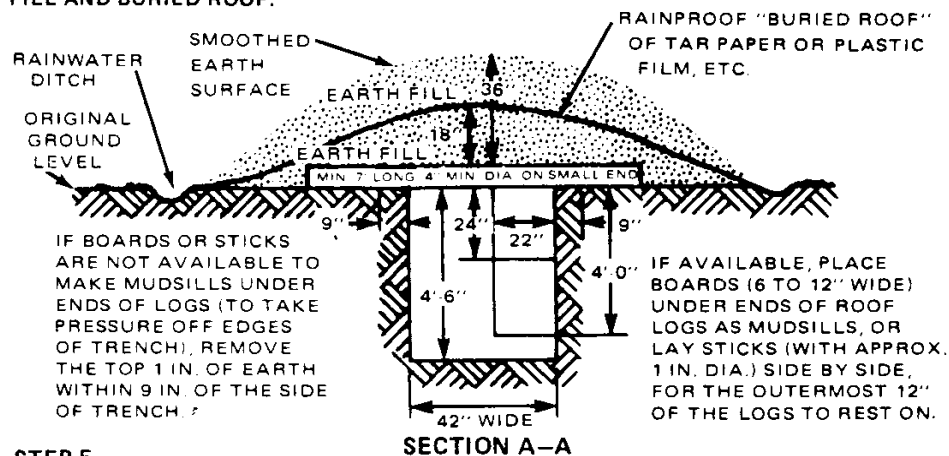

STEP 5

CONSTRUCT CANOPIES OVER THE OPENINGS

TOOLS AND MATERIALS

1. Saw and/or axe.
2. Pick or mattock.
3. Long-handled shovels.
4. Rainproofing material (plastic or polyethylene) 25 square yards. For each person above 4, add 2 sq. yds.
5. 50 feet of strong string or cord and a knife.
6. Tape measure or yard stick.
7. At least 8 pillow cases and/or sandbags.
8. Work gloves.
9. Bed sheets for use as "chairs" or "hammocks" - 1 per person at least 15 feet of strong rope or cord per bed sheet.
10. 15 pounds of newspapers to place over roof logs to keep earth from falling through cracks between logs

APPROX. NO. OF POLES REQ'D.	
45 - 7' LONG	4" DIA.
10 - 5' LONG	4" DIA.

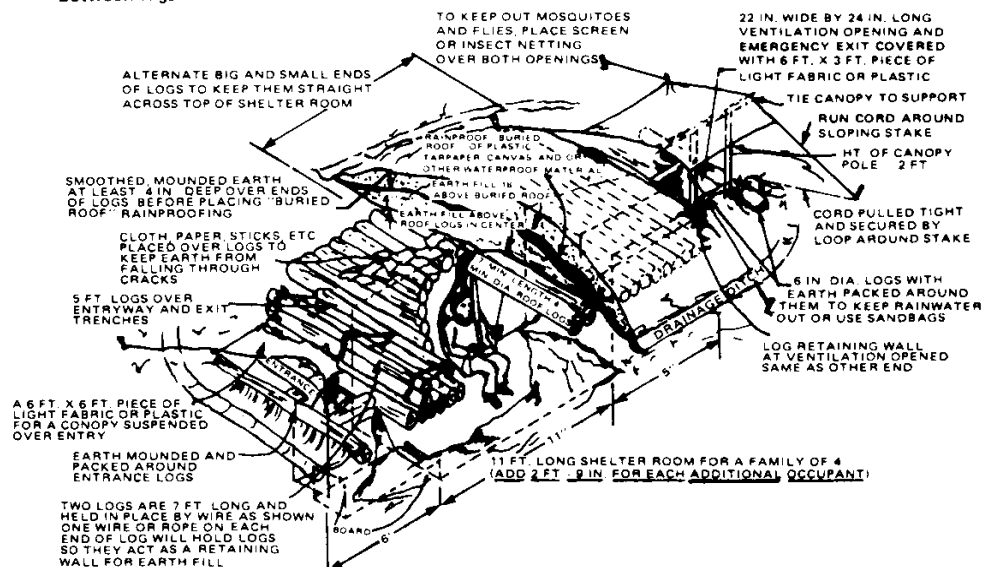

PICTORIAL VIEW OF LOG-COVERED TRENCH SHELTER WITH PART OF THE ROOF CUT AWAY TO SHOW THE RAINPROOF "BURIED ROOF".